

GENERAL INFORMATION

	Page
TERMS & CONDITIONS	2
GENERAL INFORMATION	4
ORDERING INFORMATION	5
SMARTKEY	12

BOX PACK

		Page
WEISER	Handlesets	32
	Levers	40
	Knobs	47
	Deadbolts	49
	Pocket Doorlocks	53
	Specifications	55
ELEMENTS	Handlesets	60
	Levers	63
	Knobs	66
	Deadbolts	68
	Specifications	70
SAFELOCK	Levers	74
	Knobs	76
	Deadbolts	77
	Specifications	79

VISUAL PACK

		Page
ELECTRONICS	Halo Select	16
	Halo Touch	16
	Halo	16
	Aura Reach	16
	SmartCode 10 Commercial Lever	17
	SmartCode 10 Residential Lever	17
	Smartcode Traditional Touchpad	17
	Smartcode Contemporary Touchpad	17
	Smartcode Traditional Keypad	17
	Smartcode Contemporary Keypad	18

Effective March 18 2026
Updated March 18, 2026



Scan here for the latest copy of this document. Available on weiserlock.com.

VISUAL PACK

		Page
ELECTRONICS	Powerbolt 3	18
	Elements Contemporary Keypad	18
	Elements Traditional Keypad	18
	SmartCode Handlesets	19
	Home Connect	21
	Specifications	22
WEISER	Handlesets	82
	Levers	87
	Knobs	90
	Deadbolts	92
	Combo Packs	94
ELEMENTS	Pocket Doorlocks	95
	Handlesets	97
	Levers	99
	Deadbolt	102
	Knobs	101
SAFELOCK	Combo Packs	103
	Handleset	106
	Levers	107
	Knobs	110
PADLOCKS	Deadbolts	111
	Combo Packs	111
	Outdoor- Everyday	113
	Outdoor - Professional	119
	Travel	121
	Key Storage	122
	Bicycle Storage	123

PARTS & ACCESSORIES

	Page
PARTS & ACCESSORIES	124

TERMS AND CONDITIONS OF SALE

Terms of payment – Net 30 days following date of invoice. Weiser® reserves the right to charge and recover on invoices which are not paid within the above terms, a service charge of 1-1/2% a month for each month or fraction thereof during which the invoice remains unpaid, said service charge, however, not to exceed the highest applicable legal rate of interest. All orders, whether solicited or written by our sales representatives or forwarded by our customers are deemed to be mere offers to purchase in accordance with these Terms and Conditions of Sale until actually accepted by us at our home office. We reserve the right to refuse any order as well as the right to sell or not sell to any firm at our sole discretion. The acceptance of an order is expressly made conditional upon your assent to these Terms and Conditions of Sale. We object to the inclusion of any different or additional terms or conditions, even if the same are included in your order, a contract of sale will result upon the Terms and Conditions of Sale stated herein only.

PRICES

All prices are subject to change without notice and are not guaranteed. All taxes, duties or other charges are the responsibility of the customer.

CLAIMS

Price or shortage claims must be submitted in writing to ASSA ABLOY Opening Solutions Americas, 19701 Da Vinci, Lake Forest, CA 92610, within 30 days from the date of invoice..

CHANGES OR CANCELLATIONS

The goods purchased hereunder shall be and remain the property of Weiser until the purchase price has been paid in full by the purchaser.

CHANGES, CANCELLATIONS AND RETURNS

Beyond 2 working days of our acknowledgement date no changes can be made. Additions to an order will be handled as a separate order and must meet applicable minimum order requirements. Order cancellation on regular stock items only, or any portion thereof is allowed only upon prior written consent from Weiser, and the payment of cancellation charges deemed appropriate.

MINIMUM CHARGE

No order will be invoiced for less than \$100.00 net plus shipping charges except for lock accessory parts.

MINIMUM ANNUAL SALES VOLUME

The company reserves the right to discontinue direct sales to any customer who does not meet the minimum annual sales volume requirement. The current annual requirement is \$50,000.00. Your annual purchases are determined by accepted, noncancelled, and shipped orders received during each calendar year. Weiser reserves the right to change any or all minimum annual sales volume requirements at any time. Any customer who does not meet the annual sales volume requirements may continue to purchase Weiser products through a Weiser distributor.

RETURNS

Defective merchandise returned to our distribution centres requires prior written authorization from a Weiser Sales Rep or the Sales Office. A return goods authorization number must accompany the returned shipment. The return authorization must include an itemized listing of the merchandise and an explanation stating the reason for return. There will be a 20% product restocking fee on all returned merchandise.

FREIGHT

All goods are invoiced FOB to our warehouse. Upon delivery of shipments to the carrier, title to, and the risk of loss or

damage in transit for such shipments, passes to our customer. Weiser's standard policy is to pay freight charges on all orders to a single destination in Canada by carrier and route of our choice. Weiser reserve the right to charge a \$25 handling charge for orders that do not meet the customer's minimum.

DELIVERY CONDITIONS

Shipping schedules are our best estimates, and cannot be guaranteed. Weiser is not responsible for any direct or consequential loss or damage resulting from an inability or delay in meeting shipping schedules.

PRODUCT WARRANTY

Warranties cover the original residential user of Weiser Products against defects in material and workmanship as long as the original user occupies the residential premises upon which the Product was originally installed. This warranty DOES NOT COVER abused or misused products or non-commercial products used in commercial applications. Upon return of a defective product to Weiser Corporation, Weiser shall either replace the product or refund the purchase price, at our discretion. If a covered defect occurs, call 1-800-501-9471 in Canada or return it to Weiser, 101-255 Longside Drive, Mississauga, ON L5W 0G1. A finish deterioration occurring from the use of paints, solvents, or other chemicals is not a defect in the finish and is not covered by this warranty. Weiser is not liable for incidental or consequential damages. Some do not allow the exclusion or limitation of incidental or consequential damages, so the above exclusion may not apply to you. This warranty gives you specific legal rights and you may also have other rights that vary from state to state.

PATENT INDEMNITY

We agree to defend any suit or proceeding brought against our customer so far as based on claim that our products, or any part thereof, made solely to our specifications and furnished to our customer constitute an infringement of any U.S. patent, if notified promptly in writing and given authority, information and assistance at our expense for the defense of same, and we shall pay all damages and costs awarded therein against our customer. In case our products, or any part thereof, is in such suit held to constitute infringement and their use is enjoined, we will, at our expense and discretion, either procure for our customer the right to continue using the products or replace same with non-infringing products, or modify them so they become noninfringing, or remove such products and refund the purchase price (less depreciation, prorated from the purchase date). The foregoing states our entire liability for patent infringement by our products or any part thereof.

INTELLECTUAL PROPERTY

No person or entity may sell, distribute, advertise, market or promote Weiser branded products distributed by Weiser, ASSA ABLOY Canada Residential Ltd., without prior authorization from Weiser. Customers of Weiser who are authorized to sell Weiser branded products are referred to herein as “Customers.”

The Weiser brand and all Weiser trademarks, trade names, product depictions, colors, graphics or logos, whether or not registered or otherwise protected (the “Marks”), remain the sole and exclusive property of Weiser and nothing arising out of the relationship between Weiser and any Customer conveys to Customer any ownership rights in the Marks. Customer may use the Marks and then only in the sale or promotion of authentic Weiser products in compliance with the terms of this policy. The Marks must be used exactly in the form provided and in conformity with all Weiser trademark usage policies or guidelines, including, but not limited to, those relating to shape, color match and imprint quality. Any proposed deviation must be approved in writing by Weiser prior to use. The Marks may not be used in or as part of any Customer domain name on the Internet. Prior to any use of the Marks on goods or services, Customer must submit samples for Weiser’s approval.

Additionally, no Customer may use product depictions, graphics, logos or text relating to Weiser products that have not been provided by Weiser in connection with the advertising, promotion or sale of Weiser products without Weiser’s prior review and written approval of each such use. The Marks may not be used in or as part of any reseller or other third party (i) domain name or URL on the Internet, (ii) trademark or service mark, or (iii) company or trade name. Any action on the part of a Customer that violates the terms of this policy or otherwise impairs the value of or goodwill associated with the Marks or is otherwise not in conformity with Weiser’s standards may result in the suspension or termination of the Customer’s authorization or any other remedy permitted by law.

Weiser grants to each of its Customers limited, non-transferable, non-sublicenseable licenses of the patents relating to the Weiser products that the Customer is authorized to sell and of the copyrights in any packaging or other written materials included therewith or related thereto. Said patent and copyright licenses are solely to sell such Weiser products covered by such patents and to which such copyrights relate only to end-users and other Customers in compliance with the terms of this document. The sale of such patented Weiser products and the sale or use of such copyrighted materials by a Customer that violate the terms of this document exceed the scope of the licenses herein granted to the Customer and may constitute patent and/or copyright infringement.

STANDARDS

Weiser meets or exceeds the testing requirements specified for each product grade or rating.

- American National Standards Institute (ANSI)
- Builders Hardware Manufacturers Association (BHMA)
- Underwriters Laboratories, Inc. (UL)
- Americans with Disabilities Act (ADA)

MISCELLANEOUS

Substitution of non-Weiser components/parts, and any alteration or modification of factory parts, and other lock manufacturer’s parts may result in door hardware which does not function properly or will fail and will void all warranties. Orders not specified with keying requirements will be shipped Keyed Differently (KD). Orders with keying requirements of K10 or more must have a “Letter of Release” on file with Weiser stating that Weiser Corporation will not be held liable for cost and expense arising from any loss or damage to property utilizing Weiser products where 10 or more locks have been keyed alike. Contact your Sales Office account representative for a copy of the release form. Weiser reserves the right to revise or modify products, product information, or pricing without notice. Product specifications and pricing reflect available information at the time of printing. Weiser is not responsible for typographic or printing errors.

In the interest of personal security and safety, all locksets and latchset functions that may be used on exterior doors, will be shipped from the factory with deadlocking latches only. Orders received for these functions that indicate spring latches will be converted to deadlocking latches.

In the interest of personal security and safety, all locksets and latchset functions that may be used on exterior doors, will be shipped from the factory with deadlocking latches only. Orders received for these functions that indicate spring latches will be converted to deadlocking latches.

BACKSET

Backset is the distance from center edge of door to center of the 2-1/8" (54mm) diameter hole, 2-3/8" or 2-3/4" in most cases.

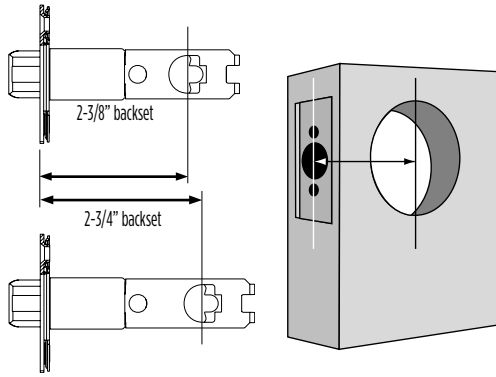

UNDERWRITERS LABORATORIES LISTED LOCKSETS

To meet Underwriters Laboratories' fire rating requirements UL listed locksets, UL listed latches, and UL listed strikes must be used together.



AMERICAN WITH DISABILITIES ACT

Please contact Weiser for products that comply with the Americans with Disabilities Act of 1990.



SERIES DESIGNATION CHOOSE FROM

	Series	Description
SAFELOCK	SK	Knobsets
	SL	Leversets
	SD	Deadbolts
	SH	Handlesets
ELECTRONIC DEADBOLTS ELEMENTS	GED	Electronics
	GAC	Knobset
	GAC/GLC	GAC - Knob, GLC - Lever Interior Packs
	GLC	Leversets
	GDC	Deadbolts
	GAC	Handlesets LIP
	GAC/GLC	Combo Pack
WEISER	GA	Knobset
	GA/GLA	GA - Knob, GLA - Lever Interior Packs
	GLA	Leversets
	GD/SSD/SDD/GCD	Deadbolts
	GA	Handlesets LIP
	GSC/GSL	Combo Pack

**** NEW simplified ordering process ** All Weiser & Safe Lock products are now ordered by part number**

NOTE: All box pack handlesets are ordered LESS INTERIOR PACK (LIP). Interior packs must be ordered separately

FUNCTION NUMBER

Model	Function
101/1000	Passage/Hall/Closet
331/3000	Privacy/Bed/Bath
531/535/5000	Keyed Entry
581	Storeroom/Vestibule
12/7000	Inactive Trim, Surface or Bolt through mounting
1030/1031	Pocket Door Lock
9771/1100/8771	Single Cylinder Handleset
9675/8675	Interior Pack for Weiser Handlesets
1471/9471/9100	Single Cylinder Deadbolts
9571	Key Control Deadbolts
9240/9250	Elements Keypad/Powerbolt3
9260/9270/2600/2700	SmartCode/SmartCode Lever
2400/2500/3000	Halo/Halo Touch
9400/9800	Aura Reach/Halo Select
7451/7481/6000	Combo Packs

NOTE: All box pack handlesets are ordered LESS INTERIOR PACK (LIP). Interior packs must be ordered separately

ORDERING INFORMATION

STYLE

		Series	Description			Series	Description		
KNOBS & LEVERS	SAFELOCK	AS	Athens	KNOBS & LEVERS	WEISER	PGK	Prague (knob)		
		DAL	Dayton			PHL	Perth		
		GV	Grapevine			PVL	Prava		
		LY	Layton			SEL	Sedona		
		MZK	Mezo			SAL	Singapore		
		RG	Regina			SYL	Sydney		
		REL	Reminy			SOK	Sora		
		WTL	Westley			TC	Toluca		
		WI	Winston			TDL	Trafford		
	ELEMENTS	AI	Alfini		HANDLESETS	SAFELOCK	BRN	Branton	
		BLM	Belmont				DT	Daytona	
		B	Beverly				ELEMENTS	AMD	Amador
		BRNL	Breton					BDH	Brentwood
		CSL	Casey					HYH	Henley
		F	Fairfax			KNH		Kingsway	
		HYL	Henley			WEISER		A	Augusta
		HSL	Hollis				BFH	Brentford	
		KML	Kim				CRH	Caerus	
		MNK	Maven				HE	Hawthorne	
TSL	Tristan	H	Heritage						
WEISER	Y	Yukon	PGH	Prague					
	CBK	Cambie	PTH	Prescott					
	D	Dane	PVH	Prava					
	HFL	Halifax	SCE	San Clemente					
	HT	Huntington	TVH	Tavaris					
	KAL	Katella	VNH	Vancouver					
	LSL	Lisbon							
	MAL	Mirada							
	MIL	Milan							
	MRL	Montreal							
P	Phoenix								
PEL	Pesaro								
PGL	Prague (lever)								

FINISH

Finish	Description	ANSI / BHMA
3	Polished Brass	605
3BR	Lifetime Polished Brass	605E
4	Satin Brass	-
11P	Venetian Bronze	-
15	Satin Nickel	619
18G	Gunmetal	
26	Polished Chrome	625
26D	Satin Chrome	626
514	Matte Black	-
9/32D	Bright Bronze/ Satin Chrome	
514/15	Matte Black/Satin Nickel	-

KEYING

CHOOSE FROM

Code	Description
KD	Keyed Differently
K2, K3	Keyed Alike (2 Locksets, 3 Locksets)
MK	Master Keyed
CK	Builder (Construction) Keyed
CMK	Builder (Construction) Master Keyed
SMT	SmartKey
WS	Weiser Pin & Tumbler
KW	KW Pin & Tumbler

NOTE: SMT (SmartKey) is the default configuration for all Weiser products, excluding Safelock

PACKAGING

CHOOSE FROM

B Box Pack	MS Merchandiser Sensomatic	VS Visual Pack
-------------------	-----------------------------------	-----------------------

HANDING (LEVERS)

CHOOSE FROM

LH Left Hand	RH Right Hand
---------------------	----------------------

To determine the handing of a door face the **OUTSIDE** of the door. If the hinge is on the left side of the door, the door is left handed (LH). If the hinge is on the right side of the door, the door is right handed (RH).

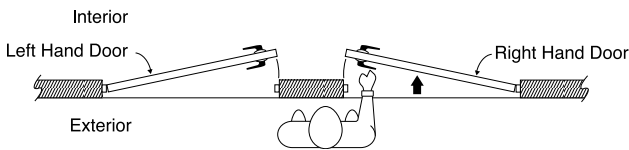

NOTE: Handing required for Inactive levers and handlesets with handed levers

FIRE RATINGS

IF REQUIRED:

Code	Description
UL	UL 3 Hour Rated Fire Door
FD	20 Minute Rated Fire Door (FD)

LATCH CONFIGURATION

CHOOSE FROM

Latch	Description
SL/SCAL	Square Corner Adjustable Latch
RL/RCAL	Radius Corner Adjustable Latch
DI/RFAL	Round Face Drive-in Latch
4L	4-Way Adjustable Latch
6L	6-Way Adjustable Latch

STRIKE CONFIGURATION

CHOOSE FROM

Code	Description
R1	Radius Cornered Strike (Interior/Exterior)
R2	Radius Cornered Strike (Deadbolts)
R3	1/4" (6.4mm) Radius Full Lip Deadbolt Strike
S1	Square Cornered Strike (Interior/Exterior)
S2	Square Cornered Strike (Deadbolts)
S3	Square Corner Full Lip Deadbolt Strike
S5	Square Cornered Strike (For Metal Frames)
T1	T-Strike (4-7/8" Length, ASA Strike)
T2	T-Strike (2-3/4", ANSI Strike), Exterior
T3	Square Corner T-Strike for Deadbolt
DS	Square and Radius Cornered Strike (Interior pack Only)

SPECIALITY KEYING ORDERING INFORMATION

CYLINDER OPTIONS

PRODUCT CODE	DESCRIPTION	HANDLESETS	DEADBOLTS	KNOBS & LEVERS
SMT	5 pin SmartKey Re-Keying Technology with KWI Keyway Default	✓	✓	✓
WS	Weiser 5-pin Pin & Tumbler	Limited	Limited	Limited
KW	Kwikset 5-pin Pin & Tumbler	Limited	Limited	Limited

KEYING OPTIONS

KEYING	DESCRIPTION	SMT	WS	KW	ADDITIONAL CHARGE	NOTES	ORDERING EXAMPLE - CONFIRMATION NOMENCLATURE
KD	Keyed Different - Each lock is individually keyed to a different key cut	✓	✓	✓	No Charge	1 set of 2 keys cut the same (additional keys can be ordered through service parts program)	Qty 12 - 9SSD94710-023
KA	SmartKey Keyed Alike - All locks are keyed to same key cut number	✓			\$6.00	Only available with a given cylinder type, SMT keyway cannot be keyed alike to WS keyway. Included: 1 set of 2 keys cut to same number for entire series	Qty 12 - 9SSD94710-023 KA12
WITH	With - All locks across multiple lines are keyed to same key cut	✓	✓	✓	No Charge	Only available with a given cylinder type, SMT keyway cannot be keyed alike to WS keyway. Included: 1 set of 2 keys cut to same number for entire series	Qty 12 - 9SSD94710-023 WITH Qty 12 - 9SSD94710-023 KA2
KEY CODE	Customer selects the specific key cut that they would like the cylinder to be keyed to	✓	✓	✓	No Charge	Customer must specify the 5 digit code they would like the cylinders to be keyed to	Qty 12 - 9SSD94710-023 NOTES: KA12 TO: 45325
CK	Construction Keyed - Allows new homes to be keyed to a builder's key during construction. After homeowner uses their key, the builder key is rendered inoperable	✗	✓	✓	\$19.00	Only available with WS and KW keyways. Included: 4 Construction Keys and 1 set of 2 keys cut to same number for each lock	Qty 12 - 9SSD94710-052 CK
MK	Master Keyed - Allows multiple keys to operate a single lock. Often used in multi-family applications for owners and tenants.	✗	✓	✓	\$19.00	Only available with WS and KW keyways. Included: 4 Master Keys and 1 set of 2 keys cut to the same number for each lock	Qty 4 - 9SSD94710-052 MK
CMK	Construction Master Keyed - Allows multiple keys to operate a single lock, with the added functionality of a Construction Key. Often used in multi-family applications.	✗	✓	✓	\$23.00	Only available with WS and KW keyways. Included: 4 Master Keys, 10 Construction Keys and 1 set of 2 keys cut to same number for each lock	Qty 4 - 9SSD94710-052 CMK
XKEY	Orders will ship with no keys in product boxes. Often used in multi-family applications.	✓	✓	✓	No Charge	Keys will arrive in envelopes prior to product shipment.	Qty 12 - 9SSD94710-052 XKEY
TC/BC GCD9571 SMT	Key Control Deadbolt application: Top Cylinder (TC) = Master Cylinder Bottom Cylinder (BC) = Tenant Cylinder	✓	✗	✗	\$6.00	Only available with SMT keyways. Included: default 2-TC keys and 2 BC-keys. For KA options, see multi-family order example guide.	Qty 4 - 9GCD95710-033 NOTES: TC KA4 TO: 45325, BC KD
STAMPING	Keys are stamped to requested key code or key designation such as MK, CK, 2AA or DNC (Do Not Copy)	✗	✓	✓	No Charge	Only available with WS and KW keyways.	QTY 4 - 9SSD94710-052 CMK STAMPING NOTES PER REQUIREMENTS

Intro

Electronics

Box Pack

Visual Pack

Padlocks

Parts

LATCH OPTIONS

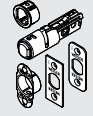
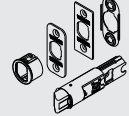
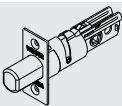
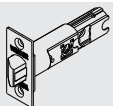
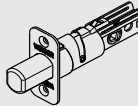
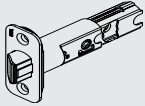
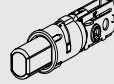
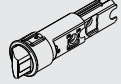
PRODUCT CODE	DESCRIPTION	DEADBOLTS	KNOBS & LEVERS
6L	Latch with kit including collar, back plate, and round and square fronts		
SL/*SCAL	Adjustable latch with Square-Corner Front		
RL/*RCAL	Adjustable latch with Radius-Corner Front		
DI/*RFAL	Adjustable latch with Drive-in Collar or Round Face		

STRIKE OPTIONS

PRODUCT CODE	DESCRIPTION	DEADBOLTS	KNOBS & LEVERS
S1 / S2 / *SCS	Square Corner strike: S1 = knob/lever, S2 = deadbolt, SCS = Safelock		
R1 / R2 / *RCS	Radius Corner Strike = R1 = knob/lever, R2 = deadbolt, RCS = Safelock		
T3 / T2	T Strike (Metal Door Frame Application)		
T6	ANSI ASA-1 Strike (Metal Door Frame Application)	N/A	
SS / *SS303	Two Hole Metal Door Deadbolt Strike		N/A

* Denotes Safelock descriptions

KEY TABLE

WS	TENANT	800000-125	800000-125
	MK	800004-342	N/A
	CK	800004-340	N/A
KW	TENANT	800004-353	800004-355
	MK	800004-355	N/A
	CK	800004-353	N/A
KEY CONTROL	TOP (TC)	820204-001	820231-001
	BOTTOM (BC)	800004-353	800004-355

KEYING ORDER SAMPLE EXAMPLES:

SMT KA - 1 LINE EXAMPLE	
96 - 9SSD94710-023 KA96 XKEY	
Order Notes:	10 - KA Keys (800004-353 K20 TO DEADBOLT LINE) 5 - RK Keys (800004-353 K10 RANDOM) 192 - TK Keys (800004-353 K4 RANDOM)
Sample Notes:	New project Smartkey, deadbolts are keyed alike to KA key - Used as construction key on site Requesting 20 Keyed Alike Keys - 20 keys that are cut the same and currently operate the locks Requesting 10 Realtor Keys - 10 keys that are cut the same but use a random bitting Requesting 384 Tenant Keys - 96 sets of K4 random bitting sets Requesting all deadbolts ship XKEY - Keys shipped in envelopes and not in individual boxes

* Two keys per ring, total quantity must be an even amount. Ordering instructions are 1/2 total amount.

SMT KA - 2 LINE EXAMPLE	
48 - 9SSD94710-023 KA48 XKEY	
24 - 9SSD94710-023 KA24 XKEY	
Order Notes:	LINE 1 - KEY ALL ALIKE LINE 2 - KEY ALL ALIKE TO LINE 1 5 - KA Keys (800004-353 K10 TO DEADBOLT LINE) 96 - TK Keys (800004-353 K4 RANDOM)
Sample Notes:	New project Smartkey, deadbolts are keyed alike to KA key - Used as construction key on site Requesting 10 Keyed Alike Keys - 10 keys that are cut the same and currently operate the locks Requesting 192 Tenant Keys - 48 sets of K4 random bitting sets Requesting all deadbolts ship XKEY - Keys shipped in envelopes and not in individual boxes

* Two keys per ring, total quantity must be an even amount. Ordering instructions are 1/2 total amount.

KEY CONTROL - 1 LINE EXAMPLE	
170 - 9GCD95710-033 KA170 XKEY	
Order Notes:	3 - TC Keys (820204-001 K6 TO TOP CYLINDER) 13 - BC Keys (800004-353 K26 TO BOTTOM CYLINDER) 5 - RK Keys (800004-353 K10 RANDOM) 340 - TK Keys (800004-353 K4 RANDOM)
Sample Notes:	New Key Control project- top cylinders are KA as the master key, bottom cylinders are KA which are used as construction keys on site Requesting 6 Top Cylinder Keys - 6 keys that are cut the same and currently operate the top cylinder of the locks Requesting 26 Bottom Cylinder Keys - 26 keys that are cut the same and currently operate the bottom cylinder of the locks Requesting 10 Realtor Keys - 10 keys that are cut the same but use a random bitting Requesting 680 Tenant Keys - 170 sets of K4 random bitting sets Requesting all deadbolts ship XKEY - Keys shipped in envelopes and not in individual boxes

* Two keys per ring, total quantity must be an even amount. Ordering instructions are 1/2 total amount.

Intro

Electronics

Box Pack

Visual Pack

Padlocks

Parts

KEYING ORDER SAMPLE EXAMPLES:

KEY CONTROL - 2 LINE EXAMPLE	
<p>80 - 9GCD95710-033 KA80 XKEY 80 - 9SSD94710-023 KA80 XKEY</p>	
Order Notes:	<p>LINE 1 - KEY ALL TOP CYLINDERS ALIKE TO ANY - KEY ALL BOTTOM CYLINDERS ALIKE TO ANY LINE 2 - KEY ALL ALIKE TO BOTTOM CYLINDER ON LINE 1 5 - TC Keys (820204-001 K10 TO TOP CYLINDER) 13 - BC Keys (800004-353 K26 TO BOTTOM CYLINDER) 160 - TK Keys (800004-353 K4 RANDOM)</p>
Sample Notes:	<p>New Key Control project- top cylinders are KA as the master key, bottom cylinders & SSD9471 cylinders are KA which are used as construction keys on site Requesting 10 Top Cylinder Keys - 10 keys that are cut the same and currently operate the top cylinder of the locks Requesting 26 Bottom Cylinder Keys - 26 keys that are cut the same and currently operate the bottom cylinder of the locks Requesting 320 Tenant Keys - 80 sets of K4 random biting sets Requesting all deadbolts ship XKEY - Keys shipped in envelopes and not in individual boxes</p>

** Two keys per ring, total quantity must be an even amount. Ordering instructions are 1/2 total amount.*

WS CMK - EXAMPLE	
<p>60 - 9SSD94710-052 CMK WITH 60 - 9SSD94710-052 K2</p>	
Order Notes:	<p>5 - MK Keys (800004-342 K5) MK TO ANY 10 - CK Keys (800004-340 K10) CK TO ANY CMK LINE 1 ONLY</p>
Sample Notes:	<p>Construction Master Keyed project 60 units project - 2 deadbolts KA per unit (Suite entry door is CMK FD & deck door is KA to suite entry) Requesting 5 Master Keys Requesting 10 Construction Keys Requesting 60 sets of Tenant Keys, 4 keys per ring</p>

**CK keys are ordered in singles, order amount required, default is 5.*

**MK keys have a default of 5 keys, however can be ordered in singles*

**Tenant keys do not need to be requested, default is two per lock*

**Keys arrive in individual boxes when ordered as (WS) / Keys arrive in envelopes when ordered as (XKEY)*

WS MK - 1 LINE EXAMPLE	
<p>80 - 9SSD94710-052 MK KD</p>	
Order Notes:	<p>5 - MK Keys (800004-342 K5) MK TO ANY</p>
Sample Notes:	<p>Master Keyed, Keyed Different 80 units project - 1 deadbolt per unit Requesting 5 Master Keys</p>

**MK keys have a default of 5 keys, however can be ordered in singles*

**Tenant keys do not need to be requested, default is two per lock*

**Keys arrive in individual boxes when ordered as (WS) / Keys arrive in envelopes when ordered as (XKEY)*



SMARTKEY SECURITY™

THE ONLY LOCK YOU CAN RE-KEY IN SECONDS!

What is SmartKey?

SmartKey™ is a technology that allows you to re-key a lock in just seconds while improving security without removing the lock from the door.

How Does it Work?

SmartKey™ has a patented side locking bar technology that replaces the traditional pin and tumbler design. This new design includes BumpGuard™ for improved security against lock-bumping, an attack technique that can defeat traditional pin and tumbler locks.

SUPERIOR SECURITY

It's why we buy locks in the first place. With SmartKey™ technology from Weiser you are guaranteed to have one of the most secure residential deadbolts on the market.

ANSI Graded Deadbolts

Deadbolt locks are rated by an independent agency (ANSI) on a grade scale; with Grade 3 being good, and Grade 1 being the best.

How does SmartKey rate?

All of our SmartKey deadbolts are ANSI rated and approved. In our Collections family of products, many of our SmartKey deadbolts are rated as Grade 1 - providing you with the very best residential security on the market and featuring the highest level of pick resistance available.

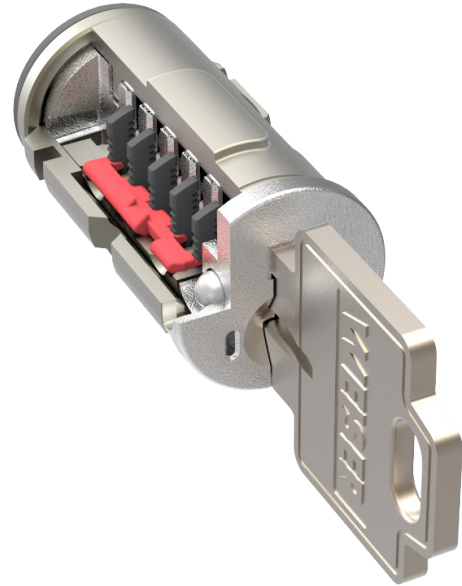

Available in All Weiser Keyed Functions

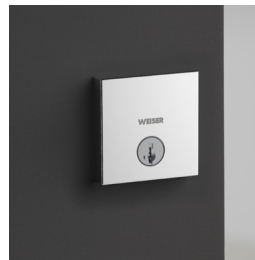

Deadbolts



Handlesets



Levers



Knobs



BEFORE YOU START...

These steps show you how to change from the current key that operates the lock to a new key you want to operate the lock. For new purchases, the current key is the one that was supplied with the lockset.

Be sure to install the product on the door first, prior to rekeying.

These instructions illustrate a deadbolt for demonstration purposes, but these SmartKey rekeying instructions also apply to keyed knobs, levers, and handlesets.

DEFINITIONS

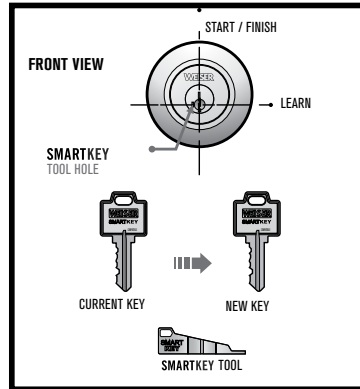

www.weiserlock.com/smartkey

STEP 1 TURN TO LEARN POSITION

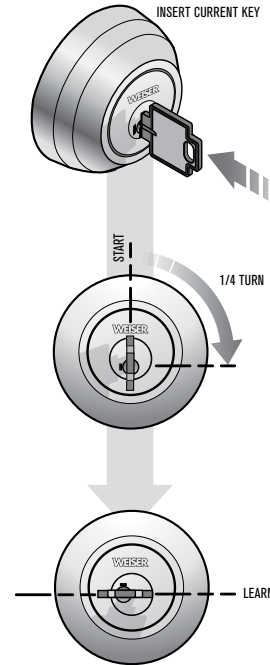

STEP 2 INSERT AND REMOVE SMART KEY TOOL

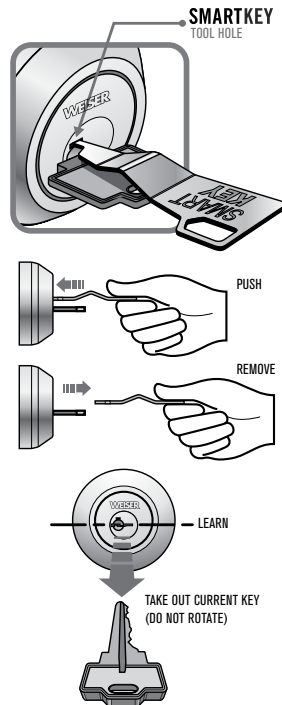

STEP 3 LEARN NEW KEY

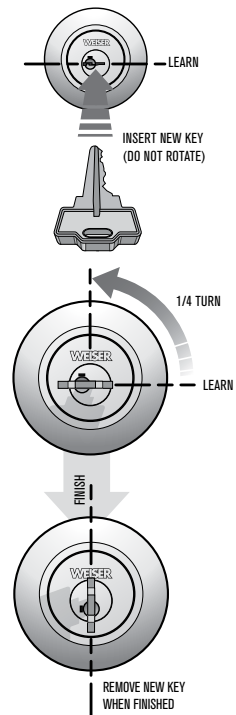



Intro

Electronics

Box Pack

Visual Pack

Padlocks

Parts



A Before you begin, rotate lower dial to the right till it stops to align arrow on upper grip with start point ① on inner dial.



B Insert cylinder all the way into the inner dial.



C Rotate lower dial half turn to the left till it stops, where the two arrows meet.

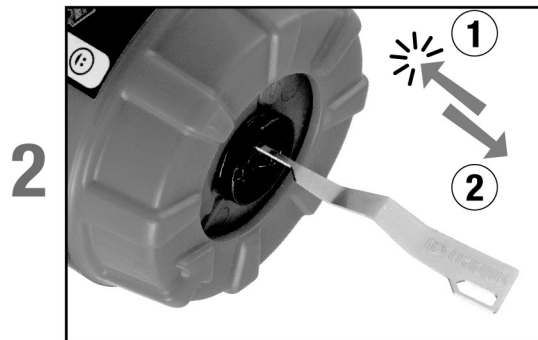

A Insert the SmartKey tool into the small hole (next to the keyway) on the cylinder face, and push with force till it goes all the way in, then remove the SmartKey tool.



B Insert the key you want to learn in the plug, while being sure not to rotate the plug

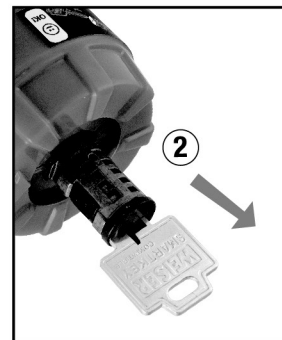

C Remove the plug from the reset cradle by gently pulling on the key.

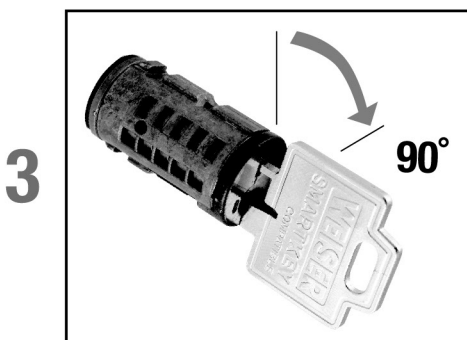

A While holding the cylinder body stationary, rotate the key back to the home position.

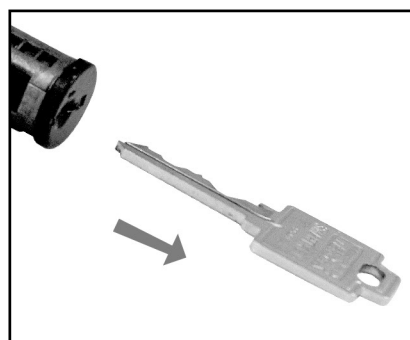

B Remove the key.



C Reinstall cylinder in product



ELECTRONICS

Intro

Electronics

Box Pack

Visual Pack

Padlocks

Parts

HALO SELECT		Finish Availability	GED 9800
15	Satin Nickel	9GED98000-001	
514	Matte Black	9GED98000-002	
List Price		\$800	
Case Quantity		1	



HALO TOUCH		Finish Availability	GED 3000
514	Matte Black	9GED30000-004	
List Price		\$662	
Case Quantity		1	



HALO KEYPAD		Finish Availability	GED 2400
15	Satin Nickel	9GED24000-001	
514	Matte Black	9GED24000-003	
List Price		\$510	
Case Quantity		1	



HALO TOUCHSCREEN		Finish Availability	GED 2500
15	Satin Nickel	9GED25000-003	
514	Matte Black	9GED25000-004	
List Price		\$580	
Case Quantity		1	



AURA REACH		Finish Availability	GED 9400
15	Satin Nickel	9GED94000-001	
514	Matte Black	9GED94000-002	
List Price		\$490	
Case Quantity		1	



SMARTCODE 10 COMMERCIAL LEVER



Finish Availability		GED 2600
15	Satin Nickel	9GED26000-001
514	Matte Black	9GED26000-002
List Price		\$377
Case Quantity		1



SMARTCODE 10 LEVER



Finish Availability		GED 2700
15	Satin Nickel	9GED27000-001
514	Matte Black	9GED27000-002
List Price		\$370
Case Quantity		1



SMARTCODE TRADITIONAL TOUCHPAD



Finish Availability		GED 9270
15	Satin Nickel	9GED92700-001
514	Matte Black	9GED92700-002
List Price		\$336
Case Quantity		2



SMARTCODE CONTEMPORARY TOUCHPAD



Finish Availability		GED 9270
15	Satin Nickel	9GED92700-003
514	Matte Black	9GED92700-004
List Price		\$336
Case Quantity		2



SMARTCODE TRADITIONAL KEYPAD



Finish Availability		GED 9260
15	Satin Nickel	9GED92600-001
514	Matte Black	9GED92600-002
List Price		\$284
Case Quantity		2



Intro

Electronics

Box Pack

Visual Pack

Padlocks

Parts

Intro

Electronics

Box Pack

Visual Pack

Padlocks

Parts

SMARTCODE CONTEMPORARY KEYPAD



Finish Availability		GED 9260
15	Satin Nickel	9GED92600-003
26D	Satin Chrome	9GED92600-005
514	Matte Black	9GED92600-004
List Price		\$284
Case Quantity		2



20 min.

POWERBOLT 3



Finish Availability		GED 9250
3	Brass	9GED92500-001
11P	Venetian Bronze	9GED92500-004
15	Satin Nickel	9GED92500-002
26D	Satin Chrome	9GED92500-003
514	Matte Black	9GED92500-005
List Price		\$215
Case Quantity		2



ELEMENTS CONTEMPORARY KEYPAD



Finish Availability		GED 9240
15	Satin Nickel	9GED92400-005
514	Matte Black	9GED92400-006
List Price		\$158
Case Quantity		2





ELEMENTS TRADITIONAL KEYPAD





Finish Availability		GED 9240
15	Satin Nickel	9GED92400-003
514	Matte Black	9GED92400-004
List Price		\$158
Case Quantity		2





Prescott x SmartCode Traditional Keypad		Finish Availability	GLA9260 TRL PTH/KAL
	15	Satin Nickel	9GLA92600-001
	514	Matte Black	9GLA92600-002
			
		Interior	Katella
		List Price	\$588
		Case Quantity	2



San Clemente x SmartCode Contemporary Keypad		Finish Availability	GLA9260 CNT SCE/HFL
	15	Satin Nickel	9GLA92600-003
	514	Matte Black	9GLA92600-004
			
		Interior	Halifax
		List Price	\$588
		Case Quantity	2



Henley x Powerbolt 3 Keypad		Finish Availability	GLA9250 TRS/HYH/HYL
	15	Satin Nickel	9GLA92500-003
	514	Matte Black	9GLA92500-004
			
		Interior	Henley
		List Price	\$404
		Case Quantity	2



HALIFAX LED		Function	101 Hall/Closet	331 Bed/Bath
	15	Satin nickel	9GLA1010-196	9GLA3310-176
	514	Matte Black	9GLA1010-197	9GLA3310-177
		List Price	\$100	\$117
		Case Quantity	4	4

Intro

Electronics

Box Pack

Visual Pack

Padlocks

Parts

Intro

Electronics

Box Pack

Visual Pack

Padlocks

Parts

HOME CONNECT 620 TRADITIONAL



3	Brass	9GED18005-003
11P	Venetian Bronze	9GED18005-002
15	Satin Nickel	9GED18005-001
List Price		Contact your Weiser Rep for pricing and to order today
Case Quantity		1



HOME CONNECT 620 CONTEMPORARY



15	Satin Nickel	9GED18005-004
514	Matte Black	9GED18005-006
List Price		Contact your Weiser Rep for pricing and to order today
Case Quantity		1



HOME CONNECT 918 TRADITIONAL



11P	Venetian Bronze	9GED21520-002
15	Satin Nickel	9GED21520-001
List Price		Contact your Weiser Rep for pricing and to order today
Case Quantity		1



HOME CONNECT 918 CONTEMPORARY		
15	Satin Nickel	9GED21520-003
514	Matte Black	9GED21520-004
List Price		Contact your Weiser Rep for pricing and to order today
Case Quantity		1



HOME CONNECT LEVER		
11P	Venetian Bronze	9GED14550-006
15	Satin Nickel	9GED14550-005
List Price		Contact your Weiser Rep for pricing and to order today
Case Quantity		1

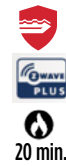

Intro

Electronics

Box Pack

Visual Pack

Padlocks

Parts

All Electronics product meets ASTM E 331 water penetration testing

HALO SELECT

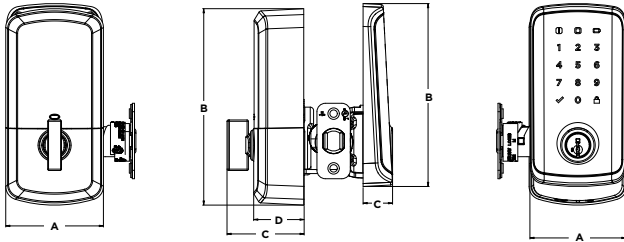

Interior

Exterior

Design	A	B	C	D
Interior	2-29/32" (73 mm)	5-27/32" (148 mm)	2-9/32" (57 mm)	1-1/2" (38 mm)
Exterior	2-27/32" (72 mm)	5-7/16" (138 mm)	7/8" (22 mm)	-

Function	Single cylinder deadbolt
Door Prep	2 1/8" diameter cross bore hole & 1" diameter edge bore hole
Latch Backset	Adjustable 2 3/8" or 2 3/4"
Door Thickness	1 3/4" standard. Service part available for 2 3/4" thick doors.
Faceplates	1" x 2 1/4" square corner standard
Strikes	2 3/4" x 1 1/8" square corner, 4 hole strike
Bolt	1" throw, steel deadbolt
Door Handing	Reversible for right or left-hand doors
Cylinder	SmartKey Security™
Temp Range & Humidity	Temperature Range: Exterior: -40F to 150F Interior: 32F to 130F Humidity: Exterior: 100% condensing Interior: 30% - 95% non-condensing

HALO TOUCH

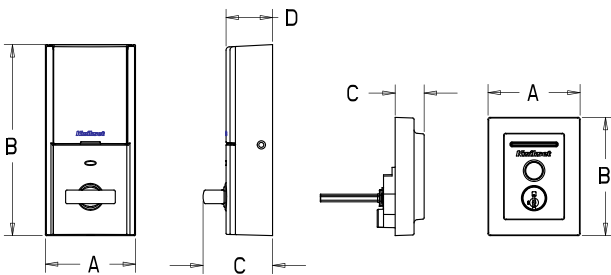

Interior

Exterior

Design	A	B	C	D
Interior	2-23/32" (69 mm)	5-25/32" (147 mm)	2-2/32" (53 mm)	1-13/32" (36 mm)
Exterior	2-25/32" (71 mm)	3-9/16" (91 mm)	7/8" (22 mm)	---

Function	Single cylinder deadbolt
Door Prep	2 1/8" diameter bore hole & 1" diameter latch hole
Backset	Adjustable 2-3/8" or 2-3/4"
Door Thickness	1-3/4" - 2" automatic adjustment
Faceplates	1" x 2-1/4" square corner standard
Strikes	Square corner strike 2-3/4" x 1-1/8"
Latch	Square & drive-in adjustable 2-3/8" x 2-3/4"
Bolt	1" throw, steel deadbolt
Door Handing	Reversible
Cylinder	SmartKey Security™
Temp Range & Humidity	Temperature Range: Exterior: -40F to 150F Interior: 32F to 130F Humidity: Exterior: 100% condensing Interior: 30% - 95% non-condensing

All Electronics product meets ASTM E 331 water penetration testing

HALO TOUCHSCREEN

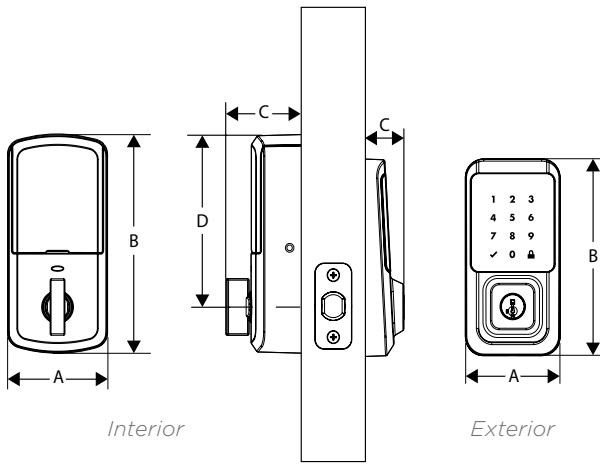

Design	A	B	C	D
Interior	2-3/4" (70 mm)	5-13/16" (147 mm)	2-1/8" (53 mm)	4-9/16" (116 mm)
Exterior	2-28/32" (73 mm)	5-5/8" (143 mm)	1-3/16" (30 mm)	-

Function	Single cylinder deadbolt
Door Prep	2-1/8" diameter bore hole & 1" diameter latch hole
Backset	Adjustable 2-3/8" or 2-3/4"
Door Thickness	1-3/8" - 2" automatic adjustment
Faceplates	1" x 2-1/4" square corner standard
Strikes	Square corner, 4-hole strike, 2-3/4" x 1-1/8"
Latch	Square corner and drive-in adjustable 2-3/4" x 2-1/8"
Bolt	1" throw, steel deadbolt
Door Handing	Reversible
Cylinder	SmartKey Security™
UL	Meets 20 minute fire rating

AURA REACH

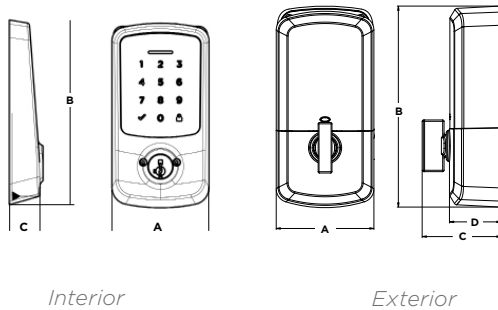

Design	A	B	C	D
Interior	2-1/4"	5-13/16"	2-1/8"	4-9/16"
Exterior	2-23/32"	4-5/8"	1-3/16"	---

Power	12-month battery life with 4 AA Alkaline batteries
Door Prep	2-1/8" diameter bore hole & 1" diameter edge bore hole
Latch Backset	Adjustable 2-3/8" or 2-3/4"
Door Thickness	1-3/4" - standard Service part available for 2 1/4" thick doors
Faceplates	1" x 2 1/4" square corner standard
Strikes	2-3/4" x 1-1/8" Square corner, 4 hole strike,
Latch	Square & drive-in adjustable, 2-3/8" x 2-3/4"
Bolt	1" throw, steel deadbolt
Door Handing	Reversible for right or left-hand doors
Cylinder	SmartKey Security™
UL Rated	20 minute UL fire rating
Security	Deadbolt: A156.36 Grade 2 Certified
Temperature Range	Exterior: -40°C to 85°C (40°F to 185°F) Interior: 0°C to 54°C (32F to 130F)
Humidity	Exterior: 100% Condensing, Interior: 30% to 95% non-condensing

All Electronics product meets ASTM E 331 water penetration testing

SMARTCODE 10 COMMERCIAL LEVER

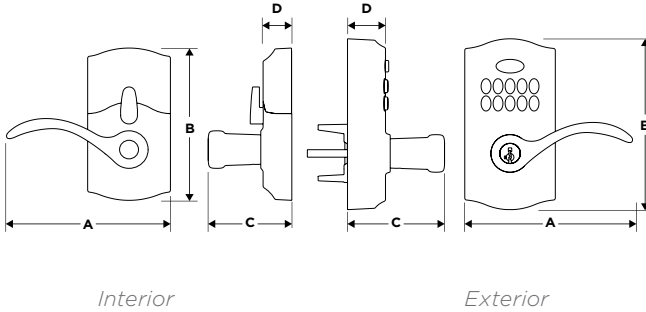

Design	AB		CD	
Interior	5-5/8"	5-5/16"	2-7/8"	31/32"
Exterior	5-3/4"	5-31/32"	3-5/16"	1-13/32"

Function	Keyed entry electronic lever
Door Prep	2-1/8" diameter face hole & 1" diameter latch hole
Backset	Adjustable to 2-3/8" or 2-3/4"
Door Thickness	1-3/8" - 1-3/4"
Faceplates	1" x 2-1/4" Square corner standard
Strikes	Square corner, 4 hole strike, 2-3/4" x 1-1/8"
Latch	Square corner adjustable 2-3/8" x 2-3/4"
Bolt	1/2" throw, dead latch
Door Handing	Reversible
Cylinder	SmartKey Security™
UL	Meets 20 minute fire rating

SMARTCODE 10 LEVER

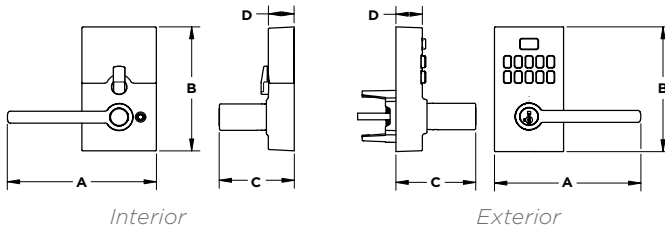

Design	A	B	C	D
Interior	5-21/32"	4-7/8"	2-27/32"	31/32"
Exterior	5-9/16"	4-29/32"	3-1/32"	1"

Function	Keyed entry electronic lever
Door Prep	Cross Bore 2-1/8". Edge Bore 1"
Backset	Adjustable to 2-3/8" or 2-3/4"
Door Thickness	1-3/8" - 1-3/4"
Faceplates	1" x 2-1/4" Square corner standard
Strikes	Square corner, 2-1/4" full lip
Latch	Adjustable to 2-3/8" or 2-3/4"
Bolt	1/2" throw, dead latch
Door Handing	Reversible
Cylinder	SmartKey Security™
UL	Meets 20 minute fire rating
Temperature Range	Exterior: -40F to 150F Interior: 32F to 130F
Humidity	Exterior: - 100% condensing Interior: 30% - 95% non-condensing

All Electronics product meets ASTM E 331 water penetration testing

SMARTCODE KEYPAD

CONTEMPORARY

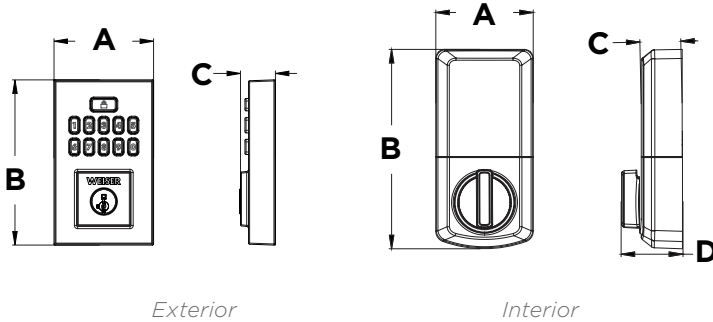

Design	A	B	C	D
Interior	2-3/4" (69 mm)	5-1/2" (140 mm)	1-1/8" (29 mm)	1-11/16" (43.2 mm)
Exterior	2-3/4" (71 mm)	4-9/16" (116 mm)	1" (25 mm)	---

TRADITIONAL

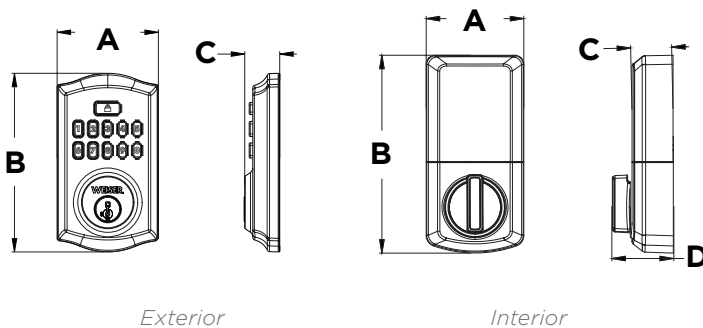

Design	A	B	C	D
Interior	2-3/4" (69 mm)	5-1/2" (140 mm)	1-1/8" (29 mm)	1-11/16" (43.2 mm)
Exterior	2-13/16" (71.7 mm)	5" (127 mm)	1" (25 mm)	---

Battery	Uses 4 x AA 6V alkaline cell batteries with approximately 1 year battery life
Function	Single cylinder deadbolt
Door Prep	1-1/2" (38mm) or 2-1/8" (54mm) diameter cross bore hole and 1" diameter edge bore hole
Backset	Adjustable 2-3/8" (60mm) or 2-3/4" (70mm)
Door Thickness	1-3/8" (35mm) to 1-3/4" (44mm) standard. Thick door service part available for 2-1/4" (57mm) thick doors.
Faceplates	1" (25 mm) x 2-1/4" (57 mm) square corner faceplate with drive-in collar stand
Strikes	2-3/4" (70mm) x 1-1/8" (29mm) square corner 4 hole strike
Bolt	1" (25mm) throw, steel bolt with anti-saw security pin
Door Handing	Reversible
Cylinder	SmartKey Security™
Temperature Range	Exterior: -40°F to 150°F (-40°C to 66°C) Interior: 32°F to 130°F (0°C to 54°C)
Humidity	Exterior: 100% condensing Interior: 30% to 95% non-condensing
Codes	Up to 50 user codes and 10 one-time user codes with optional programming code

All Electronics product meets ASTM E 331 water penetration testing

SMARTCODE TOUCHPAD

CONTEMPORARY

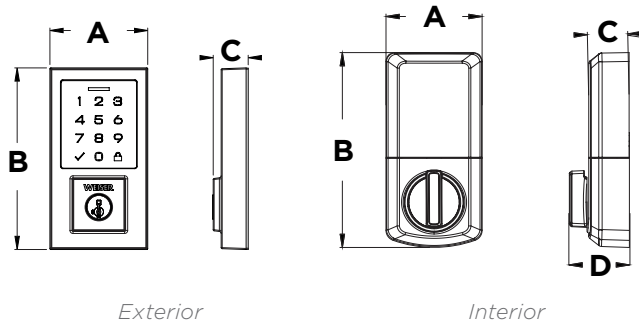

Design	A	B	C	D
Interior	2-3/4" (70 mm)	5-3/16" (132 mm)	1" (25 mm)	1-11/16" (43 mm)
Exterior	2-3/4" (70 mm)	5-1/2" (140 mm)	1-1/8" (29 mm)	---

TRADITIONAL

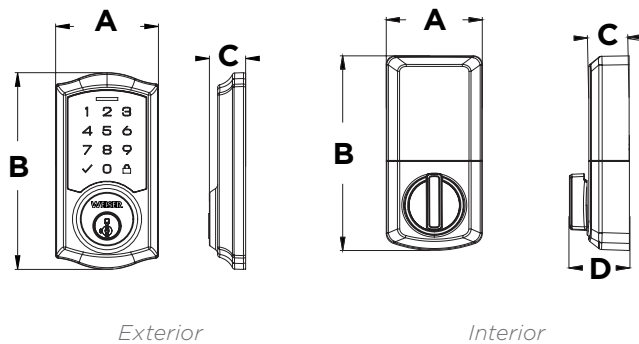

Design	A	B	C	D
Interior	2-13/16" (71 mm)	5-3/8" (137 mm)	1" (25 mm)	1-11/16" (43 mm)
Exterior	2-3/4" (70 mm)	5-1/2" (140 mm)	1-1/8" (29 mm)	---

Battery	Uses 4 x AA 6V alkaline cell batteries with approximately 1 year battery life
Function	Single cylinder deadbolt
Door Prep	1-1/2" (38mm) or 2-1/8" (54mm) diameter cross bore hole and 1" diameter edge bore hole
Backset	Adjustable 2-3/8" (60mm) or 2-3/4" (70mm)
Door Thickness	1-3/8" (35mm) to 1-3/4" (44mm) standard. Thick door service part available for 2-1/4" (57mm) thick doors.
Faceplates	1" (25 mm) x 2-1/4" (57 mm) square corner faceplate with drive-in collar standard
Strikes	2-3/4" (70mm) x 1-1/8" (29mm) square corner 4 hole strike
Bolt	1" (25mm) throw, steel bolt with anti-saw security pin
Door Handing	Reversible
Cylinder	SmartKey Security™
Temperature Range	Exterior: -40°F to 150°F (-40°C to 66°C) Interior: 32°F to 130°F (0°C to 54°C)
Humidity	Exterior: 100% condensing Interior: 30% to 95% non-condensing
Codes	Up to 50 user codes and 10 one-time user codes with optional programming code

All Electronics product meets ASTM E 331 water penetration testing

POWERBOLT 3

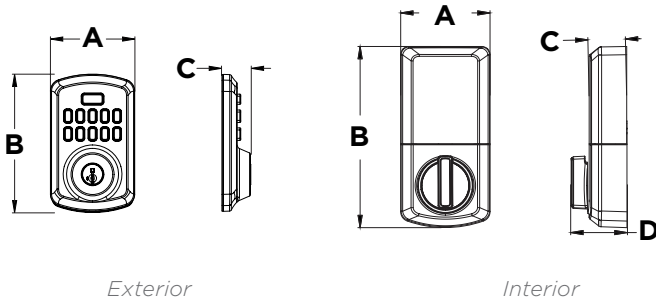

Design	A	B	C	D
Interior	2-7/8"	7-7/16"	1-3/4"	5-15/16"
Exterior	2-3/4"	4-3/4"	1-15/16"	---

Battery	6V, 4 x AA alkaline batteries, 12-month battery life (batteries not included)
Function	Single cylinder deadbolt
Door Prep	1-1/2" or 2-1/8" diameter cross bore hole and 1" diameter edge bore hole
Backset	Adjustable 2-3/8" or 2-3/4"
Door Thickness	1-3/8" to 1-3/4" standard. Service part available for 2 1/4" thick doors
Faceplates	1" x 2-1/4" sound corner faceplate with drive-in collar standard
Strikes	2-3/4" x 1-1/8" sound corner 2-hole strike
Bolt	1" throw, steel bolt
Door Handing	Reversible
Cylinder	SmartKey Security™ KW1 cylinder
Temperature Range	Exterior: -40°F to 150°F (-40°C to 66°C) Interior: 32°F to 130°F (0°C to 54°C)
Humidity	Exterior: 100% condensing Interior: 30% to 95% non-condensing
Codes	Up to 25 user codes and 5 one-time user codes with optional programming code

All Electronics product meets ASTM E 331 water penetration testing

ELEMENTS KEYPAD

CONTEMPORARY

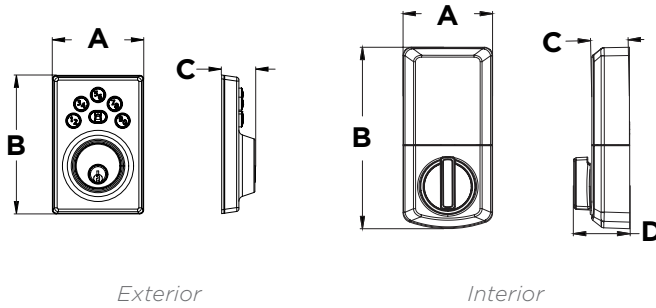

Design	A	B	C	D
Interior	2-23/32"	5-1/2"	1-5/32"	1-11/16"
Exterior	2-25/32"	4-7/32"	1-1/32"	---

TRADITIONAL

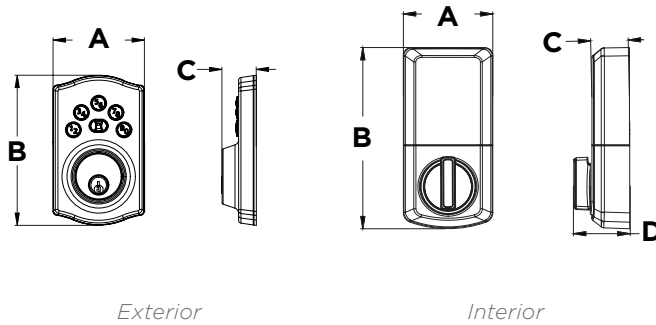

Design	A	B	C	D
Interior	2-23/32"	5-1/2"	1-5/32"	1-11/16"
Exterior	2-11/16"	4-7/16"	1-1/32"	---

Battery	6V, 4 x AA alkaline batteries, 12-month battery life (batteries not included)
Function	Single cylinder deadbolt
Door Prep	1-1/2" or 2-1/8" diameter cross bore hole and 1" diameter edge bore hole
Backset	Adjustable 2-3/8" or 2-3/4"
Door Thickness	1-3/8" to 1-3/4" standard. Service part available for 2-1/4" thick doors
Faceplates	1" x 2-1/4" sound corner faceplate with drive-in collar standard
Strikes	2-3/4" x 1-1/8" sound corner 2-hole strike
Bolt	1" throw, steel bolt
Door Handing	Reversible
Cylinder	KW1 P&T cylinder
Temperature Range	Exterior: -40°F to 150°F (-40°C to 66°C) Interior: 32°F to 130°F (0°C to 54°C)
Humidity	Exterior: 100% condensing Interior: 30% to 95% non-condensing
Codes	Up to 12 user codes and 2 one-time user codes with optional programming code

All Electronics product meets ASTM E 331 water penetration testing

HOME CONNECT 620

CONTEMPORARY

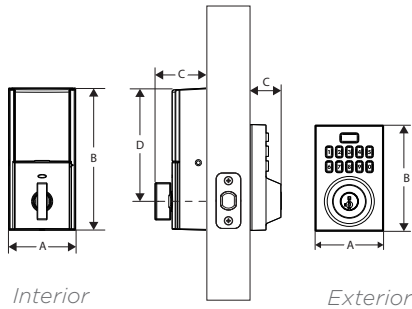

Design	A	B	C	D
Interior	2-23/32"	5-25/32"	2-1/8 "	4-1/2 "
Exterior	2-25/32"	4-5/16 "	1-1/4 "	---

TRADITIONAL

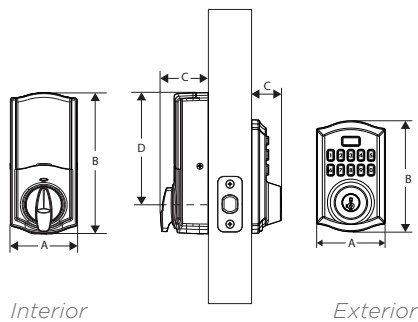

Design	A	B	C	D
Interior	2-23/32"	5-25/32"	1-15/16"	4-19/32"
Exterior	2-13/16"	4-9/16"	1-1/4"	---

Battery	6V (4 x AA alkaline batteries) 12-month battery life (batteries not included)
Function	Single cylinder deadbolt
Door Prep	1-1/2" and 2-1/8" diameter cross bore hole and 1" edge bore latch hole
Backset	Adjustable 2-3/8" or 2-3/4"
Door Thickness	1-3/8" - 2"
Faceplates	1" x 2-1/4" square corner standard
Strikes	Square corner strike 2-3/4"x 2-1/8"
Bolt	1" throw, steel deadbolt
Door Handing	Reversible
Cylinder	SmartKey Security™
Temperature Range	Exterior: -40°F to 150°F Interior: 32°F to 140°F
Humidity	Exterior: 100% condensing Interior: 30% - 95% non-condensing
Codes	Customize up to 250 user codes.

All Electronics product meets ASTM E 331 water penetration testing

HOME CONNECT 918

CONTEMPORARY

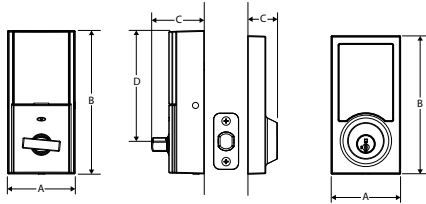

Interior

Exterior

Design	A	B	C	D
Interior	2-23/32"	5-25/32"	2-1/8 "	4-1/2 "
Exterior	2-25/32"	5-17/32 "	1-3/16 "	---

TRADITIONAL

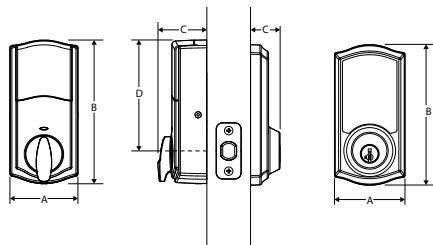

Interior

Exterior

Design	A	B	C	D
Interior	2-23/32"	5-25/32"	1-15/16"	4-19/32"
Exterior	2-13/16"	5-5/8"	1-3/16"	---

Battery	6V (4 x AA alkaline batteries) 12-month battery life (batteries not included)
Function	Single cylinder deadbolt
Door Prep	1-1/2" and 2-1/8" diameter cross bore hole and 1" edge bore latch hole
Backset	Adjustable 2-3/8" or 2-3/4"
Door Thickness	1-3/8" - 2"
Faceplates	1" x 2 1/4" square corner standard
Strikes	Square corner strike 2-3/4"x 2-1/8"
Bolt	1" throw, steel deadbolt
Door Handling	Reversible
Cylinder	SmartKey Security™
Temperature Range	Exterior: -40°F to 150°F Interior: 32°F to 140°F
Humidity	Exterior: 100% condensing Interior: 30% - 95% non-condensing
Codes	Customize up to 250 user codes.

BOX PACK

Intro

Electronics

Box Pack

Visual Pack

Padlocks

Parts

HANDLESETS GROUP A	Function	GA8771 Single Cylinder
	List Price	\$406

PRAVA	Finish Availability	GA8771 PVH
	15 Satin Nickel	9GA87710-014
	514 Matte Black	9GA87710-015
Case Quantity		4

HANDLESETS GROUP B	Function	GA8771 Single Cylinder
	List Price	\$384

BRENTFORD	Finish Availability	GA8771 BFH
	15 Satin Nickel	9GA87710-018
	514 Matte Black	9GA87710-017
Case Quantity		4

PRAGUE	Finish Availability	GA8771 PGH
	15 Satin Nickel	9GA87710-009
	26 Polished Chrome	9GA87710-011
	26D Satin Chrome	9GA87710-012
	514 Matte Black	9GA87710-010
Case Quantity		4

NOTE: All box pack handlesets are ordered LESS INTERIOR PACK (LIP). Interior packs must be ordered separately.

HANDLESETS GROUP B	Function	GA9771 / GA8771 Single Cylinder	GA7771 Handleset Minus
	List Price	\$384	\$298

SAN CLEMENTE	Finish Availability	GA8771 SCE	GA7771 SCE/HFL ONLY
	4 Satin Brass	9GA87710-016	--
	15 Satin Nickel	9GA87710-001	9GLA77710-007
	18G Gunmetal	9GA87710-019	--
	26 Polished Chrome	9GA87710-013	--
	26D Satin Chrome	9GA87710-002	--
	514 Matte Black	9GA87710-003	9GLA77710-001
Case Quantity		4	2

TAVARIS	Finish Availability	GA9771 TVH
	15 Satin Nickel	9GA97710-030
	26 Polished Chrome	9GA97710-031
	26D Satin Chrome	9GA97710-032
	514 Matte Black	9GA97710-026
	Case Quantity	4

15 Satin Nickel	9GA97710-039	
26D Satin Chrome	9GA97710-038	
514 Matte Black	9GA97710-037	
Case Quantity	4	

VANCOUVER	Finish Availability	GA8771 VNH
	15 Satin Nickel	9GA87710-007
	514 Matte Black	9GA87710-008
	Case Quantity	4

*Halifax Full Trim Escutcheon available for Vancouver Handleset only. See Page 32 for SKU number.



NOTE: All box pack handlesets are ordered LESS INTERIOR PACK (LIP). Interior packs must be ordered separately.

Intro

Electronics

Box Pack

Visual Pack

Padlocks

Parts

HANDLESETS GROUP C	Function	GA9771 Single Cylinder
	List Price	\$360

AUGUSTA	Finish Availability	GA9771 A
	15 Satin Nickel	9GA97710-003
	26D Satin Chrome	9GA97710-005
	514 Matte Black	9GA97710-007
	Case Quantity	6

HAWTHORNE	Finish Availability	GA9771 HE
	11P Venetian Bronze	9GA97710-022
	15 Satin Nickel	9GA97710-025
	Case Quantity	6

NOTE: All box pack handlesets are ordered LESS INTERIOR PACK (LIP). Interior packs must be ordered separately.

Compatible with Brentford, Prague, San Clemente & Vancouver	Function		GLA8675 Single Cylinder	GLA8675 Single Cylinder	GLA8675 Full Escutcheon	GLA86 Inactive	GLA86 Inactive
	List Price		\$79	\$79	\$100	\$79	\$79
BRETON	Finish Availability		SQUARE ROSE	ROUND ROSE		SQUARE ROSE	ROUND ROSE
15	Satin Nickel	9GLA86750-046	9GLA86750-045	--		9GLA860-005	9GLA860-006
26	Polished Chrome	9GLA86750-043	9GLA86750-042	--		9GLA860-003	9GLA860-004
26D	Satin Chrome	9GLA86750-044	--	--		--	--
514	Matte Black	9GLA86750-041	9GLA86750-040	--		9GLA860-001	9GLA860-002
CAMBIE	Finish Availability		SQUARE ROSE	ROUND ROSE			
15	Satin Nickel	9GA86750-001	9GA86750-003				
514	Matte Black	9GA86750-002	9GA86750-004				
HALIFAX	Finish Availability		SQUARE ROSE	ROUND ROSE	FULL ESCUTCHEON		
4	Satin Brass	9GLA86750-067	--	--			
15	Satin Nickel	9GLA86750-001	9GLA86750-048	9GLA86750-021			
18G	Gunmetal	9GLA86750-074	--	--			
26D	Satin Chrome	9GLA86750-002	--	--			
514	Matte Black	9GLA86750-003	9GLA86750-047	9GLA86750-022			
LISBON	Finish Availability		SQUARE ROSE	ROUND ROSE			
15	Satin Nickel	9GLA86750-017	9GLA86750-050				
514	Matte Black	9GLA86750-018	9GLA86750-049				
MIRADA	Finish Availability		SQUARE ROSE				
15	Satin Nickel	9GLA86750-068					
514	Matte Black	9GLA86750-069					
MILAN	Finish Availability		SQUARE ROSE	ROUND ROSE			
15	Satin Nickel	9GLA86750-054	9GLA86750-055				
26	Polished Chrome	--	9GLA86750-053				
514	Matte Black	9GLA86750-051	9GLA86750-052				
MONTREAL	Finish Availability		SQUARE ROSE				
15	Satin Nickel	9GLA86750-016					
PERTH	Finish Availability						
15	Satin Nickel	9GLA86750-038					
514	Matte Black	9GLA86750-039					

Intro

Electronics

Box Pack

Visual Pack

Padlocks

Parts

HANDLESET INTERIOR PACK

Intro

Compatible with Brentford, Prava, Prague, San Clemente & Vancouver	Function	GLA8675 Single Cylinder	GLA8675 Single Cylinder
	List Price	\$79	\$106

Electronics

PESARO	Finish Availability		ROUND ROSE
15	Satin Nickel	9GLA86750-070	
514	Matte Black	9GLA86750-071	

Box Pack

PRAGUE LEVER	Finish Availability		
15	Satin Nickel	9GLA86750-026	
26	Polished Chrome	9GLA86750-028	
26D	Satin Chrome	9GLA86750-029	
514	Matte Black	9GLA86750-027	

Visual Pack

PRAGUE KNOB	Finish Availability		
15	Satin Nickel	9GA86750-005	
26	Polished Chrome	9GA86750-007	
26D	Satin Chrome	9GA86750-008	
514	Matte Black	9GA86750-006	

Padlocks

Parts

PRAVA	Finish Availability		
15	Satin Nickel		9GLA86750-065
514	Matte Black		9GLA86750-066

Compatible with Brentford, Prava, Prague, San Clemente & Vancouver	Function	GLA8675 Single Cylinder	GLA8675 Single Cylinder
	List Price	\$79	\$79

SEDONA	Finish Availability		LEFT HANDED	RIGHT HANDED
	4	Satin Brass	9GLA86750-035	9GLA86750-034
	15	Satin Nickel	9GLA86750-031	9GLA86750-030
	514	Matte Black	9GLA86750-033	9GLA86750-032

SINGAPORE	Finish Availability		SQUARE ROSE	ROUND ROSE
	15	Satin Nickel	9GLA86750-023	9GLA86750-059
	26	Polished Chrome	9GLA86750-025	9GLA86750-057
	26D	Satin Chrome	9GLA86750-058	--
	514	Matte Black	9GLA86750-024	9GLA86750-056

SORA	Finish Availability		
	15	Satin Nickel	9GA86750-009
	514	Matte Black	9GA86750-010

SYDNEY	Finish Availability		SQUARE ROSE	ROUND ROSE
	15	Satin Nickel	9GLA86750-063	9GLA86750-064
	26D	Satin Chrome	9GLA86750-062	--
	514	Matte Black	9GLA86750-060	9GLA86750-061

TRAFFORD	Finish Availability		
	15	Satin Nickel	9GLA86750-036
	514	Matte Black	9GLA86750-037

HANDLESET INTERIOR PACK

Compatible with Augusta, Hawthorne and Tavaris	Function	GLA9675 Single Cylinder	GLA9675 Single Cylinder
	List Price	\$79	\$79

BRETON	Finish Availability		SQUARE ROSE
15	Satin Nickel	9GLA96750-174	
26D	Satin Chrome	9GLA96750-175	
514	Matte Black	9GLA96750-181	

CAMBIE	Finish Availability		SQUARE ROSE	ROUND ROSE
15	Satin Nickel	9GA96750-105	9GA96750-107	
514	Matte Black	9GA96750-106	9GA96750-108	

FAIRFAX	Finish Availability	
26D	Satin Chrome	9GA96750-075

HALIFAX	Finish Availability		SQUARE ROSE	ROUND ROSE
11P	Venetian Bronze	9GLA96750-146	--	
15	Satin Nickel	9GLA96750-148	9GLA96750-147	
26	Polished Chrome	9GLA96750-150	9GLA96750-149	
26D	Satin Chrome	9GLA96750-151	--	
514	Matte Black	9GLA96750-153	9GLA96750-152	

HUNTINGTON	Finish Availability	
15	Satin Nickel	9GA96750-076
26D	Satin Chrome	9GA96750-077

KATELLA	Finish Availability	
15	Satin Nickel	9GLA96750-179
514	Matte Black	9GLA96750-180

KIM	Finish Availability	
15	Satin Nickel	9GLA96750-133
26D	Satin Chrome	9GLA96750-182

Intro

Electronics

Box Pack

Visual Pack

Padlocks

Parts

Compatible with Augusta, Hawthorne and Tavarls	Function	GLA9675 Single Cylinder	GLA9675 Single Cylinder
	List Price	\$79	\$79

LISBON	Finish Availability		SQUARE ROSE	ROUND ROSE
15	Satin Nickel		9GLA96750-170	9GLA96750-169
514	Matte Black		9GLA96750-173	--

MILAN	Finish Availability		SQUARE ROSE	ROUND ROSE
15	Satin Nickel		9GLA96750-194	9GLA96750-154
26	Polished Chrome		--	9GLA96750-155
26D	Satin Chrome		--	9GLA96750-156
514	Matte Black		9GLA96750-192	9GLA96750-191

MONTREAL	Finish Availability		SQUARE ROSE
15	Satin Nickel		9GLA96750-157
514	Matte Black		9GLA96750-159

SINGAPORE	Finish Availability		SQUARE ROSE	ROUND ROSE
15	Satin Nickel		9GLA96750-176	9GLA96750-186
26	Polished Chrome		9GLA96750-178	9GLA96750-184
26D	Satin Chrome		9GLA96750-185	--
514	Matte Black		9GLA96750-177	9GLA96750-183

SORA	Finish Availability		
15	Satin Nickel		9GA96750-109
514	Matte Black		9GA96750-110

TOLUCA	Finish Availability		LEFT HANDED	RIGHT HANDED
3	Brass		9GLA96750-142	9GLA96750-188
15	Satin Nickel		9GLA96750-136	9GLA96750-137
514	Matte Black		9GLA96750-144	9GLA96750-190

TROY	Finish Availability		
15	Satin Nickel		9GA96750-086
26D	Satin Chrome		9GA96750-088
514	Matte Black		9GA96750-090

Intro

HALIFAX LED		Function	101 Hall/Closet	331 Bed/Bath
	15	Satin Nickel	9GLA1010-196	9GLA3310-176
	514	Matte Black	9GLA1010-197	9GLA3310-177
		List Price	\$100	\$117
		Case Quantity	4	4

Electronics

LEVERS GROUP A	Function	101 Hall/Closet	101 Hall/Closet 20 Min Fire Rated	331 Bed/Bath	535 Keyed Entry	12 Inactive
		List Price	\$90	\$90	\$107	\$161

Box Pack

DANE		Finish Availability	GLA 101 D		GLA 331 D	GLA 535 D	GLA 12 D
	26D	Satin Chrome	9GLA1010-182	--	9GLA3310-160	9GLA5350-201	9GLA120-159
			Case Quantity	12	--	12	12

Visual Pack

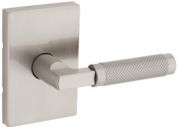
PRAVA		Finish Availability	GLA 101 PVL	GLA 101 PVL FD	GLA 331 PVL	GLA 535 PVL	GLA 12 PVL
	15	Satin Nickel	9GLA1010-194	9GLA1010-227	9GLA3310-174	9GLA5350-221	9GLA120-173
	514	Matte Black	9GLA1010-195	9GLA1010-226	9GLA3310-175	9GLA5350-222	9GLA120-174
			Case Quantity	12	12	12	12

Padlocks

MIRADA		Finish Availability		GLA 101 MAL FD	GLA 331 MAL	GLA 535 MAL	GLA 12 MAL
	15	Satin Nickel	--	9GLA1010-205	9GLA3310-180	9GLA5350-225	9GLA120-175
	514	Matte Black	--	9GLA1010-206	9GLA3310-181	9GLA5350-226	9GLA120-176
			Case Quantity	--	12	12	12

Parts

LEVERS GROUP B	Function	101 Hall/Closet	101 Hall/Closet - 20 Min Fire Rated	101 Hall/Closet - 3 Hr Rated	331 Bed/Bath	535 Keyed Entry	12 Inactive
	List Price	\$83	\$83	\$104	\$101	\$159	\$50

SINGAPORE - SQUARE ROSE	Finish Availability	GLA 101 SAL	GLA 101 SAL FD	GLA 101 SAL UL	GLA 331 SAL	GLA 535 SAL	GLA 12 SAL
	15 Satin Nickel	--	9GLA1010-120	9GLA1010-168	9GLA3310-119	9GLA5350-166	9GLA120-114
	26 Polished Chrome	9GLA1010-122	9GLA1010-222	9GLA1010-179	9GLA3310-121	9GLA5350-168	9GLA120-116
	26D Satin Chrome	9GLA1010-186	9GLA1010-221	--	9GLA3310-166	9GLA5350-213	9GLA120-165
	514 Matte Black	9GLA1010-121	9GLA1010-220	9GLA1010-169	9GLA3310-120	9GLA5350-167	9GLA120-115
Case Quantity		12	12	12	12	12	6

SINGAPORE - ROUND ROSE	Finish Availability	GLA 101 SAL	GLA 101 SLA FD	GLA 101 SAL UL	GLA 331 SAL	GLA 535 SAL	GLA 12 SAL
	15 Satin Nickel	9GLA1010-123	9GLA1010-219	9GLA1010-170	9GLA3310-122	9GLA5350-210	9GLA120-117
	26 Polished Chrome	9GLA1010-124	9GLA1010-218	9GLA1010-171	9GLA3310-123	9GLA5350-211	9GLA120-118
	514 Matte Black	9GLA1010-185	9GLA1010-217	9GLA1010-180	9GLA3310-165	9GLA5350-212	9GLA120-164
Case Quantity		12	12	12	12	12	6

HALIFAX	Finish Availability	GLA 101 HFL FD		GLA 331 HFL	GLA 535 HFL	GLA 12 HFL	
	4 Satin Brass	--	9GLA1010-152	--	9GLA3310-145	9GLA5350-186	9GLA120-138
	18G Gunmetal	--	9GLA1010-213	--	9GLA3310-186	9GLA5350-231	9GLA120-179
Case Quantity		--	12	--	12	12	6

PERTH	Finish Availability	GLA 101 PHL			GLA 331 PHL	GLA 535 PHL	GLA 12 PHL
	15 Satin Nickel	9GLA1010-165	--	--	9GLA3310-158	9GLA5350-199	9GLA120-157
	514 Matte Black	9GLA1010-166	--	--	9GLA3310-159	9GLA5350-200	9GLA120-158
Case Quantity		12	--	--	12	12	6

Intro

Electronics

Box Pack

Visual Pack

Padlocks

Parts

Intro

LEVERS GROUP B	Function	101 Hall/Closet	331 Bed/Bath	535 Keyed Entry	12 Inactive
	List Price	\$83	\$101	\$159	\$50

Electronics

PRAGUE - MODERN ROSE	Finish Availability	GLA 101 PGL	GLA 331 PGL	GLA 535 PGL	GLA 12 PGL
	15 Satin Nickel	9GLA1010-139	9GLA3310-138	9GLA5350-209	9GLA120-133
	26 Polished Chrome	9GLA1010-141	9GLA3310-140	9GLA5350-206	9GLA120-135
	26D Satin Chrome	9GLA1010-142	9GLA3310-141	9GLA5350-208	9GLA120-136
	514 Matte Black	9GLA1010-140	9GLA3310-139	9GLA5350-207	9GLA120-134
Case Quantity		12	12	12	6

Box Pack

TRAFFORD	Finish Availability	GLA 101 TDL	GLA 331 TDL	GLA 535 TDL	GLA 12 TDL
	15 Satin Nickel	9GLA1010-161	9GLA3310-154	9GLA5350-195	9GLA120-153
	514 Matte Black	9GLA1010-162	9GLA3310-155	9GLA5350-196	9GLA120-154
	Case Quantity	12	12	12	6

Visual Pack

LEVERS GROUP B	Function	101 Hall/Closet	101 Hall/Closet - 20 Min Fire Rated	331 Bed/Bath	535 Keyed Entry	12 Inactive LH	12 Inactive RH
	List Price	\$83	\$83	\$101	\$159	\$50	\$50

Padlocks

SEDONA	Finish Availability	GLA 101 SEL	GLA 101 SEL FD	GLA 331 SEL	GLA 535 SEL	GLA 12 SEL LH	GLA 12 SEL RH
	4 Satin Brass	9GLA1010-158	9GLA1010-223	9GLA3310-151	9GLA5350-192	9GLA120-150	9GLA120-149
	15 Satin Nickel	9GLA1010-156	9GLA1010-225	9GLA3310-149	9GLA5350-190	9GLA120-146	9GLA120-145
	514 Matte Black	9GLA1010-157	9GLA1010-224	9GLA3310-150	9GLA5350-191	9GLA120-148	9GLA120-147
	Case Quantity	12	12	12	12	6	6

Parts

LEVERS GROUP C	Function	101 Hall/Closet	101 Hall/Closet - 20 Min Fire Rated	101 Hall/Closet - 3 Hr Fire Rated	331 Bed/Bath	535 Keyed Entry	12 Inactive
	List Price	\$79	\$79	\$100	\$97	\$151	\$47

HALIFAX - SQUARE ROSE		Finish Availability	GLA 101 HFL	GLA 101 HFL FD	GLA 101 HFL UL	GLA 331 HFL	GLA 535 HFL	GLA 12 HFL
	11P	Venetian Bronze	9GLA1010-076	--	--	9GLA3310-075	9GLA5350-105	9GLA120-068
	15	Satin Nickel	--	9GLA1010-059	9GLA1010-177	9GLA3310-058	9GLA5350-088	9GLA120-047
	26	Polished Chrome	--	9GLA1010-079	9GLA1010-176	9GLA3310-078	9GLA5350-107	9GLA120-071
	26D	Satin Chrome	--	9GLA1010-080	9GLA1010-175	9GLA3310-079	9GLA5350-109	9GLA120-072
	514	Matte Black	--	9GLA1010-082	9GLA1010-173	9GLA3310-081	9GLA5350-110	9GLA120-074
	Case Quantity			12	12	12	12	12

HALIFAX - ROUND ROSE		Finish Availability	GLA 101 HFL	GLA 101 HFL FD	GLA 101 HFL UL	GLA 331 HFL	GLA 535 HFL	GLA 12 HFL
	11P	Venetian Bronze	9GLA1010-183	--	--	9GLA3310-161	9GLA5350-202	9GLA120-113
	15	Satin Nickel	--	9GLA1010-077	9GLA1010-178	9GLA3310-076	9GLA5350-106	9GLA120-069
	26	Polished Chrome	--	9GLA1010-078	--	9GLA3310-077	9GLA5350-108	9GLA120-070
	26D	Satin Chrome	--	9GLA1010-167	--	9GLA3310-162	9GLA5350-203	9GLA120-161
	514	Matte Black	--	9GLA1010-081	9GLA1010-174	9GLA3310-080	9GLA5350-111	9GLA120-073
	Case Quantity			12	12	12	12	12

Intro

LEVERS GROUP C	Function	101 Hall/Closet	101 Hall/Closet - 20 Min Fire Rated	331 Bed/Bath	535 Keyed Entry	12 Inactive
	List Price	\$79	\$79	\$97	\$151	\$47

Electronics

KATELLA	Finish Availability	GLA 101 KAL		GLA 331 KAL	GLA 535 KAL	GLA 12 KAL
	15 Satin Nickel	9GLA1010-130	--	9GLA3310-129	9GLA5350-174	9GLA120-124
	514 Matte Black	9GLA1010-131	--	9GLA3310-130	9GLA5350-175	9GLA120-125
	Case Quantity	12	--	12	12	6

Box Pack

LISBON - SQUARE ROSE	Finish Availability	GLA 101 LSL	GLA 101 LSL FD	GLA 331 LSL	GLA 535 LSL	GLA 12 LSL
	15 Satin Nickel	9GLA1010-095	9GLA1010-230	9GLA3310-094	9GLA5350-123	9GLA120-087
	514 Matte Black	9GLA1010-098	9GLA1010-231	9GLA3310-097	9GLA5350-127	9GLA120-090
	Case Quantity	12	12	12	12	6

Visual Pack

LISBON - ROUND ROSE	Finish Availability	GLA 101 LSL	GLA 101 LSL FD	GLA 331 LSL	GLA 535 LSL	GLA 12 LSL
	15 Satin Nickel	--	9GLA1010-094	9GLA3310-093	9GLA5350-124	9GLA120-086
	514 Matte Black	9GLA1010-184	9GLA1010-229	9GLA3310-163	9GLA5350-204	9GLA120-162
	Case Quantity	12	12	12	12	6

Padlocks

Parts

LEVERS GROUP C	Function	101 Hall/Closet	101 Hall/Closet - 20 Min Fire Rated	331 Bed/Bath	535 Keyed Entry	12 Inactive
	List Price	\$79	\$79	\$97	\$151	\$47

MILAN - SQUARE ROSE	Finish Availability		GLA 101 MIL	GLA 331 MIL	GLA 535 MIL	GLA 12 MIL	
	15	Satin Nickel	--	9GLA1010-125	9GLA3310-124	9GLA5350-169	9GLA120-119
	26D	Satin Chrome	--	9GLA1010-172	9GLA3310-164	9GLA5350-205	9GLA120-163
	514	Matte Black	--	9GLA1010-128	9GLA3310-127	9GLA5350-172	9GLA120-122
	Case Quantity		--	12	12	12	6

MILAN - ROUND ROSE	Finish Availability		GLA 101 MIL FD	GLA 331 MIL	GLA 535 MIL	GLA 12 MIL	
	15	Satin Nickel	--	9GLA1010-083	9GLA3310-082	9GLA5350-112	9GLA120-075
	26	Polished Chrome	--	9GLA1010-084	9GLA3310-083	9GLA5350-113	9GLA120-076
	26D	Satin Chrome	--	9GLA1010-085	9GLA3310-084	9GLA5350-114	9GLA120-077
	514	Matte Black	--	9GLA1010-127	9GLA3310-126	9GLA5350-171	9GLA120-121
Case Quantity		--	12	12	12	6	

MONTREAL - SQUARE ROSE	Finish Availability		GLA 101 MRL	GLA 331 MRL	GLA 535 MRL	GLA 12 MRL	
	15	Satin Nickel	9GLA1010-086	--	9GLA3310-085	9GLA5350-115	9GLA120-078
	514	Matte Black	9GLA1010-088	--	9GLA3310-087	9GLA5350-117	9GLA120-080
	Case Quantity		12	--	12	12	6

PESARO	Finish Availability		GLA 101 PEL FD	GLA 331 PEL	GLA 535 PEL	GLA 12 PEL	
	15	Satin Nickel	--	9GLA1010-211	9GLA3310-184	9GLA5350-229	9GLA120-177
	514	Matte Black	--	9GLA1010-212	9GLA3310-185	9GLA5350-230	9GLA120-178
	Case Quantity		--	12	12	12	6

Intro

LEVERS GROUP C	Function	101 Hall/Closet	331 Bed/Bath	535 Keyed Entry	12 Inactive
	List Price	\$79	\$97	\$151	\$47

Electronics

SYDNEY - SQUARE ROSE	Finish Availability	GLA 101 SYL	GLA 331 SYL	GLA 535 SYL	GLA 12 SYL
	15 Satin Nickel	9GLA1010-189	9GLA3310-169	9GLA5350-216	9GLA120-168
	514 Matte Black	9GLA1010-188	9GLA3310-168	9GLA5350-215	9GLA120-167
	Case Quantity	12	12	12	6

Box Pack

SYDNEY - ROUND ROSE	Finish Availability	GLA 101 SYL	GLA 331 SYL	GLA 535 SYL	GLA 12 SYL
	15 Satin Nickel	9GLA1010-089	9GLA3310-088	9GLA5350-118	9GLA120-081
	514 Matte Black	9GLA1010-187	9GLA3310-167	9GLA5350-214	9GLA120-166
	Case Quantity	12	12	12	6

Visual Pack

LEVERS GROUP C	Function	101 Hall/Closet	331 Bed/Bath	535 Keyed Entry	12 Inactive LH	12 Inactive RH
	List Price	\$79	\$97	\$151	\$47	\$47

Padlocks

TOLUCA	Finish Availability	GLA 101 TC	GLA 331 TC	GLA 535 TC	GLA 12 TC LH	GLA 12 TC RH
	3 Brass	9GLA1010-190	9GLA3310-170	9GLA5350-217	9GLA120-169	9GLA120-170
	15 Satin Nickel	9GLA1010-114	9GLA3310-113	9GLA5350-157	9GLA120-103	9GLA120-104
	514 Matte Black	9GLA1010-191	9GLA3310-171	9GLA5350-218	9GLA120-171	9GLA120-172
	Case Quantity	12	12	12	6	6

Parts

KNOBS GROUP A	Function	101 Hall/Closet	331 Bed/Bath	531 Keyed Entry	12 Inactive
	List Price	\$67	\$85	\$142	\$34

PRAGUE - MODERN ROSE	Finish Availability	GA 101 PGK	GA 331 PGK	GA 531 PGK	GA 12 PGK
	15 Satin Nickel	9GA1010-155	9GA3310-158	9GA5310-215	9GA120-102
	514 Matte Black	9GA1010-156	9GA3310-159	9GA5310-216	9GA120-103
	Case Quantity	12	12	12	6

SORA	Finish Availability	GA 101 SOK	GA 331 SOK	GA 531 SOK	GA 12 SOK
	15 Satin Nickel	9GA1010-160	9GA3310-163	9GA5310-220	9GA120-104
	514 Matte Black	9GA1010-161	9GA3310-167	9GA5310-221	9GA120-105
	Case Quantity	12	12	12	6

KNOBS GROUP B	Function	101 Hall/Closet	331 Bed/Bath	531 Keyed Entry	12 Inactive
	List Price	\$63	\$81	\$135	\$31

CAMBIE - SQUARE ROSE	Finish Availability	GA 101 CBK	GA 331 CBK	GA 531 CBK	GA 12 CBK
	15 Satin Nickel	9GA1010-149	9GA3310-152	9GA5310-195	9GA120-096
	514 Matte Black	9GA1010-150	9GA3310-153	9GA5310-197	9GA120-097
	Case Quantity	12	12	12	6

CAMBIE - ROUND ROSE	Finish Availability	GA 101 CBK	GA 331 CBK	GA 531 CBK	GA 12 CBK
	15 Satin Nickel	9GA1010-151	9GA3310-154	9GA5310-194	9GA120-098
	514 Matte Black	9GA1010-152	9GA3310-155	9GA5310-196	9GA120-099
	Case Quantity	12	12	12	6

Intro

Electronics

Box Pack

Visual Pack

Padlocks

Parts

KNOBS GROUP C	Function	101 Hall/Closet	331 Bed/Bath	531 Keyed Entry	581 Storeroom	12 Inactive
	List Price	\$59	\$77	\$132	\$173	\$32

HUNTINGTON	Finish Availability	GA 101 HT	GA 331 HT	GA 531 HT	GA 581 HT	GA 12 HT
	15 Satin Nickel	9GA1010-129	9GA3310-125	9GA5310-200	9GA5810-002	9GA120-083
	26D Satin Chrome	9GA1010-130	9GA3310-126	9GA5310-201	9GA5810-001	9GA120-084
Case Quantity		12	12	12	12	6

15 Satin Nickel			9GA5310-218	
26D Satin Chrome			9GA5310-217	
Case Quantity			12	

PHOENIX	Finish Availability	GA 101 P	GA 331 P	GA 531 P		GA 12 P
	15 Satin Nickel	9GA1010-132	9GA3310-128	9GA5310-204	--	9GA120-086
	Case Quantity		12	12	12	--

KNOBS GROUP D	Function	101 Hall/Closet	331 Bed/Bath	531 Keyed Entry	581 Storeroom	12 Inactive
	List Price	\$50	\$68	\$123	\$162	\$25

TROY	Finish Availability	GA 101 T	GA 331 T	GA 531 T	GA 581 T	GA 12 T
	15 Satin Nickel	9GA1010-133	9GA3310-129	9GA5310-207	--	9GA120-087
	26D Satin Chrome	9GA1010-128	9GA3310-124	9GA5310-209	9GA5810-003	9GA120-082
	514 Matte Black	9GA1010-134	9GA3310-130	9GA5310-210	--	9GA120-088
Case Quantity		12	12	12	12	6

CROSSTOWN GD1471	Finish Availability		GD1471 Single Cylinder - 20 Min Fire Rated
		4	Satin Brass
	15	Satin Nickel	9GD14710-056
	514	Matte Black	9GD14710-055
	List Price		\$112
	Case Quantity		12

DOWNTOWN GD 1471 - SQUARE	Finish Availability		GD 1471 Single Cylinder	GD1471 Single Cylinder - 20 Min Fire Rated
		4	Satin Brass	--
	15	Satin Nickel	9GD14710-026	9GD14710-062
	18G	Gunmetal		9GD14710-057
	26	Polished Chrome	9GD14710-027	9GD14710-065
	26D	Satin Chrome	9GD14710-029	9GD14710-064
	514	Matte Black	9GD14710-031	9GD14710-063
	List Price		\$112	\$112
	Case Quantity		12	12

15	Satin Nickel	--	9GD14710-042	
26D	Satin Chrome	--	9GD14710-041	
List Price		--	\$112	
Case Quantity			12	

Hometown GD1471	Finish Availability		GD1471 Single Cylinder - 20 Min Fire Rated
		15	Satin Nickel
	514	Matte Black	9GD14710-053
	List Price		\$112
	Case Quantity		12

Intro

Electronics

Box Pack

Visual Pack

Padlocks

Parts

Intro

Electronics

Box Pack

Visual Pack

Padlocks

Parts

MIDTOWN GD 1471		Finish Availability		GD 1471 Single Cylinder
	15	Satin Nickel		9GD14710-035
	26	Polished Chrome		9GD14710-037
	26D	Satin Chrome		9GD14710-038
	514	Matte Black		9GD14710-036
	List Price			\$112
Case Quantity			12	

UPTOWN GD 1471 - ROUND		Finish Availability		GD 1471 Single Cylinder	GD1471 Single Cylinder - 20 Min Fire Rated
	15	Satin Nickel		9GD14710-025	9GD14710-059
	26	Polished Chrome		9GD14710-043	9GD14710-060
	514	Matte Black		--	9GD14710-061
	List Price			\$112	\$112
	Case Quantity			12	12

GCD 9471		Finish Availability		GCD 9471 Single Cylinder	GCD9471 Single Cylinder - 3 Hr Fire Rated
	15	Satin Nickel		9GCD94710-064	9GCD94710-062
	514	Matte Black		9GCD94710-063	--
	List Price			\$103	\$124
	Case Quantity			12	12

GD 9471		Finish Availability		GD 9471 Single Cylinder - 20 Min Fire Rated
	15	Satin Nickel		9GD94710-095
	26D	Satin Chrome		9GD94710-097
	514	Matte Black		9GD94710-099
	List Price			\$100
	Case Quantity			12

3	Brass	9GD94710-103	
15	Satin Nickel	9GD94710-100	
26D	Satin Chrome	9GD94710-101	
514	Matte Black	9GD94710-102	
List Price			
Case Quantity			12

SSD 9471 - SQUARE



Finish Availability	SSD9471 Single Cylinder - 20 Min Fire Rated	SSD9471 Single Cylinder - 3 Hour UL
15 Satin Nickel	9SSD94710-024	9GCD94710-065
26 Polished Chrome	9SSD94710-026	9GCD94710-067
26D Satin Chrome	9SSD94710-028	9GCD94710-069
514 Matte Black	9SSD94710-030	9GCD94710-071
List Price	\$83	\$102
Case Quantity	12	12

15 Satin Nickel	9SSD94710-052	9GCD94710-066	
26 Polished Chrome	9SSD94710-048	9GCD94710-068	
26D Satin Chrome	9SSD94710-050	9GCD94710-070	
514 Matte Black	9SSD94710-045	9GCD94710-072	
List Price	\$83	\$102	
Case Quantity	12	12	

15 Satin Nickel	9SSD94710-038	
26 Polished Chrome	9SSD94710-039	
26D Satin Chrome	9SSD94710-040	
514 Matte Black	9SSD94710-037	
List Price	\$83	
Case Quantity	12	

15 Satin Nickel	9SSD94710-031	
26 Polished Chrome	9SSD94710-033	
514 Matte Black	9SSD94710-032	
List Price	\$83	
Case Quantity	12	

NOTE: Keyed to 23155.
No keys included.
Please order keys
below.

PART NUMBER	DESCRIPTION	LIST PRICE
84282-001	SmartKey Key Keyed to 23155 - 4 Sets of 2 Keys Keyed Alike 8	\$20.80

Intro

Electronics

Box Pack

Visual Pack

Padlocks

Parts

Intro

Electronics

Box Pack

Visual Pack

Padlocks

Parts

SSD 9471 - ROUND



Finish Availability	SSD9471 Single Cylinder - 20 Min Fire Rated	SSD9471 Single Cylinder - 3 Hour UL
15 Satin Nickel	9SSD9471-023	9GCD9471-073
26 Polished Chrome	9SSD9471-025	9GCD9471-075
26D Satin Chrome	9SSD9471-027	9GCD9471-077
514 Matte Black	9SSD9471-029	9GCD9471-079
List Price	\$83	\$102
Case Quantity	12	12

15 Satin Nickel	9SSD9471-051	9GCD9471-074
26 Polished Chrome	9SSD9471-047	9GCD9471-076
26D Satin Chrome	9SSD9471-049	9GCD9471-078
514 Matte Black	9SSD9471-044	9GCD9471-080
List Price	\$83	\$102
Case Quantity	12	12



15 Satin Nickel	9SSD9471-042
26 Polished Chrome	9SSD9471-046
26D Satin Chrome	9SSD9471-043
514 Matte Black	9SSD9471-041
List Price	\$83
Case Quantity	12



15 Satin Nickel	9SSD9471-034
26 Polished Chrome	9SSD9471-036
514 Matte Black	9SSD9471-035
List Price	\$83
Case Quantity	12



NOTE: Keyed to 23155. No keys included. Please order keys below.

PART NUMBER	DESCRIPTION	LIST PRICE
84282-001	SmartKey Key Keyed to 23155 - 4 Sets of 2 Keys Keyed Alike 8	\$20.80

GCD 9571	Finish Availability		GCD9571 Single Cylinder - 20 Min Fire Rated	GCD9571 Single Cylinder - 3 Hr Fire Rated
		15	Satin Nickel	9GCD95710-033
	26	Polished Chrome	9GCD95710-041	
	26D	Satin Chrome	9GCD95710-037	9GCD95710-038
	514	Matte Black	9GCD95710-042	
	List Price		\$105	\$126
	Case Quantity		12	12

*Cylinder cap removed to show both cylinders

GCD 9571 SQT	Finish Availability		GCD9571 Single Cylinder - 20 Min Fire Rated	GCD9571 Single Cylinder - 3 Hr Fire Rated
		15	Satin Nickel	9GCD95710-035
	26D	Satin Chrome	9GCD95710-043	
	514	Matte Black	9GCD95710-039	9GCD95710-040
	List Price		\$105	\$126
	Case Quantity		12	12

*Cylinder cap removed to show both cylinders

Intro

Electronics

Box Pack

Visual Pack

Padlocks

Parts

ROUND POCKET DOORLOCK		Finish Availability	WR1030 Passage	WR1031 Privacy
 <p><i>*Fits round 2-1/8" door prep 2-3/8" backset only</i></p>	11P	Venetian Bronze	9WR10300-020	9WR10310-020
	15	Satin Nickel	9WR10300-016	9WR10310-016
	26	Polished Chrome	9WR10300-019	9WR10310-019
	26D	Satin Chrome	9WR10300-018	9WR10310-018
	514	Matte Black	9WR10300-021	9WR10310-021
	List Price			\$42
Case Quantity			12	12

CONTEMPORARY SQUARE POCKET DOOR LOCK		Finish Availability	W1030 Passage	W1031 Privacy	
 <p><i>*Fits round 2-1/8" door prep 2-3/8" backset only</i></p>	15	Satin Nickel	9WR10300-023	9WR10310-023	
	26	Polished Chrome	9WR10300-024	9WR10310-024	
	514	Matte Black	9WR10300-025	9WR10310-025	
	List Price			\$42	\$46
	Case Quantity			12	12

SQUARE POCKET DOORLOCK		Finish Availability	W1030 Passage	W1031 Privacy
	15	Satin Nickel	9W10300-002	9W10310-009
	List Price		\$42	\$46
	Case Quantity		18	18

SPECIALITY KEYING UPCHARGE INFORMATION

UPCHARGE	KEYING & STAMPING CHARGES
	Master Keying - \$19.00
	Construction Keying - \$19.00
	Construction Master Keying - \$23.00
	SmartKey Keyed Alike - \$6.00
	Stamping - Per Key/Cylinder - N/C
	Stamping - Do Not Copy/Duplicate - N/C

All Weiser product meets ASTM E 331 water penetration testing

HANDLESETS	
Door Prep	Deadbolt: Cross Bore 2-1/8" or 1-1/2" Edge Bore 1" Latch Face 1" x 2-1/4". Handle: Cross Bore 2-1/8" Edge Bore 1" Latch Face 1" x 2-1/4"
Backset	Deadbolt: Adjustable to 2-3/8" or 2-3/4" Handle: Adjustable to 2-3/8" or 2-3/4"
Door Thickness	1-3/4" doors standard. 2-1/4" doors optional Not designed for use on 1-3/8" doors
Cylinder	SmartKey standard, see specific product for more WS and KW availability
Faceplate	1" x 2-1/4". Round corner, square corner and drive-in available in box
Strikes	Deadbolt: Cross Bore 1-1/8" x 2-3/4" Round or square radius standard in box Handle: 2-1/4" full lip Round or square radius standard in box Other options available
Bolt	Deadbolt: 1" steel Handle: 1/2" throw. Nickel plated.
Door Handling	Specify handling on all curved levers. Reversible on all straight levers
ANSI/BHMA	A156.5 Grade 1 (for deadbolt)
ADA	N/A
UL	*Meets 20 minute with Square, Radius or drive-in used

KNOBS	
Door Prep	Cross Bore 2-1/8" Edge Bore 1" Latch Face 1" x 2-1/4".
Backset	Adjustable to 2-3/8" or 2-3/4" UL 2-3/4" standard 2-3/8" optional
Door Thickness	1-3/8" - 1-3/4" doors standard. 2-1/4" doors optional
Cylinder	SmartKey standard, see specific product for more WS and KW availability
Faceplate	1" x 2-1/4". Round corner, square corner and drive-in available in box
Strikes	2-1/4" full lip. Other options available
Bolt	1/2" throw. Nickel plated
Door Handling	Reversible for right or left-handed doors
ANSI/BHMA	A156.2 Grade 2
ADA	N/A
UL	Fire rating, see specific product for availability

LEVERS	
Door Prep	Cross Bore 2-1/8" Edge Bore 1" Latch Face 1" x 2-1/4".
Backset	Adjustable to 2-3/8" or 2-3/4"
Door Thickness	1-3/8" - 1-3/4" doors standard. 2-1/4" doors optional
Cylinder	SmartKey standard, see specific product for more WS and KW availability
Faceplate	1" x 2-1/4". Round corner, square corner and drive-in available in box
Strikes	2-1/4" full lip. Other options available
Bolt	1/2" throw. Nickel plated
Door Handling	Specify handing only with Inactive levers
ANSI/BHMA	A156.2 Grade 2
ADA	Functions GLA 101, GLA 12 satisfies section 4.13.9 ADA requirement.
UL	Fire rating, see specific product for availability

DEADBOLTS - GCD 9471, GD 1471	
Door Prep	Cross Bore 2-1/8" Edge Bore 1" Latch Face 1" x 2-1/4".
Backset	Adjustable to 2-3/8" or 2-3/4"
Door Thickness	SMT 1-3/8" - 1-3/4" KW P&T 1-3/4"
Cylinder	SmartKey standard, see specific product for more WS and KW availability
Faceplate	1" x 2-1/4". Round corner, square corner and drive-in available in box
Strikes	Standard: Grade 1, 1-1/8" x 2-3/4" Other options available
Bolt	1" throw. Steel.
Door Handling	Reversible for right or left-handed doors
ANSI/BHMA	A156.5 Grade 1
ADA	Interior turn piece meets 4.13.9 ADA requirements
UL	Fire rating, see specific product for availability

SPECIFICATIONS

KEY CONTROL DEADBOLTS - GCD 9571

Door Prep	Cross Bore 2-1/8" Edge Bore 1" Latch Face 1" x 2-1/4".
Door Thickness	1-3/4"
Cylinder	2 SmartKey cylinders: 1 Standard SmartKey for users. 1 Secure new patented keyway for Key Control.
Faceplate	1" x 2-1/4"
Strikes	1-1/8" x 2-3/4"
Bolt	1" throw
ANSI/BHMA	A156.5 Grade 2
ADA	Interior turn piece meets 4.13.9 ADA requirements
UL	*Meets 3 hour fire rating for all UL functions when fronted latches used. Meets 20 minute with Square, Radius or Drive-In used. UL Ref# R10923

DEADBOLTS - GD 9471, SSD 9471

Door Prep	Cross Bore 2-1/8" or 1-1/2" Edge Bore 1" Latch Face 1" x 2-1/4".
Backset	Adjustable to 2-3/8" or 2-3/4"
Door Thickness	1-3/8" - 1-3/4" doors standard 2-1/4" doors optional
Cylinder	SmartKey standard, see specific product for more WS and KW availability
Faceplate	1" x 2-1/4". Round corner, square corner and drive-in available in box
Strikes	1-1/8" x 2-3/4" Other options available
Bolt	1" throw. Steel.
Door Handling	Reversible for right or left-handed doors
ANSI/BHMA	A156.5 Grade 2
ADA	Interior turn piece meets 4.13.9 ADA requirements
UL	Fire rating, see specific product for availability

POCKET DOOR LOCKS

Door Prep	2-1/8" Face Bore. 1" Edge Bore.
Backset	2-3/8"
Door Thickness	Adjustable for 1-3/8" or 1-3/4"
Faceplate	1" x 2-1/4" round corner. Steel. Accommodates flat and beveled doors.
Strikes	1-1/8" x 2-3/4" square corner with strike box and wood frame reinforcement. Steel. Privacy function only.
Fasteners	Standard flat or Phillips screws. #8 x 1/2" for latch, #8 x 1/2" for strike
Door Handling	Non-handed

HANDLESETS

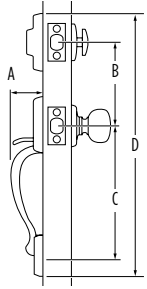

Design	A	B	C	D
Augusta	2-13/64"	5-1/2"	9-11/16"	17-45/64"
Caerus	2 11/16"	5 1/2"	8 13/32" through 9 11/16"	19 3/16"
Brentford	2 - 11/16"	5-1/2"	8-13/32" through 9-11/16"	18- 11/16"
Hawthorne	2-7/8"	5-1/2"	8-13/32"	17-9/16"
Prague	2-25/32"	5-1/2"	8-13/32" through 9-11/16"	17-23/32"
Prava	2-21/32"	5-1/2"	8-13/32" through 9-11/16"	17-15/16"
Prescott	3-1/16"	5-1/2"	8-13/32" through 9-11/16"	17-13/16"

Design	A	B	C	D
San Clemente	2-5/8"	5-1/2"	8-13/32" through 9-11/16"	17-29/32"
Tavaris	2-17/32"	5-1/2"	9-11/16"	18"
Vancouver	2-21/32"	5-1/2"	8-13/32" through 9-11/16"	17-29/32"

LEVERS

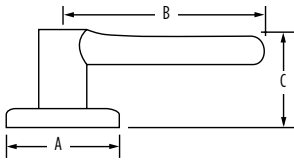

Design	A	B	C	C (Keyed)
Dane	2-5/8"	3-11/16"	2-1/2"	
Halifax (Round Rose)	2-11/16"	4-1/4"	2-1/4"	2-9/16"
Halifax (Square Rose)	2-11/16"	4-1/4"	2-1/4"	2-9/16"
Lisbon (Round Rose)	2-11/16"	4-7/32"	2-1/4"	2-9/16"
Lisbon (Square Rose)	2-11/16"	4-7/32"	2-1/4"	2-9/16"
Katella	2-11/16"	4-1/4"	2-15/32"	
Katella (Keyed)	2-11/16"	4-1/4"	2-3/8"	2-9/16"
Milan (Round Rose)	2-11/16"	4-5/32"	2-1/4"	2-9/16"
Milan (Square Rose)	2-11/16"	4-5/32"	2-1/4"	2-9/16"
Mirada (Square Rose)	2-11/16"	4-1/4"	2-3/8"	2-9/16"
Montreal (Round Rose)	2-11/16"	4-7/32"	2-1/4"	2-9/16"
Montreal (Square Rose)	2-11/16"	4-7/32"	2-1/4"	2-9/16"

Design	A	B	C	C (Keyed)
Prague	2-11/16"	4-1/4"	2-1/2"	
Prava	2-25/32"	4-1/4"	2-3/8"	2-13/32"
Perth	2-21/32"	4-1/4"	2-7/16"	2-11/32"
Pesaro	2-11/16"	4-7/32"	2-1/4"	2-9/16"
Sedona	2-21/32"	4-1/4"	2-17/32"	
Sedona (Keyed)	2-21/32"	4-9/32"	2-5/16"	
Singapore (Round Rose)	2-11/16"	4-7/32"	2-9/16"	
Singapore (Square Rose)	2-11/16"	4-7/32"	2-9/16"	
Sydney (Round Rose)	2-11/16"	4-1/4"	2-1/4"	2-9/16"
Sydney (Square Rose)	2-11/16"	4-1/4"	2-1/4"	2-9/16"
Toluca	2-5/8"	4-7/32"	2-3/32"	
Trafford	2-21/32"	4-5/32"	2-19/32"	2-9/16"

KNOBS

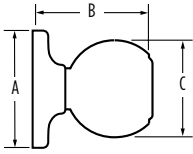

Design	A	B	C	C (Keyed)
Cambie	2-5/8"	2-13/32"	2-6/7"	
Huntington	2-5/8"	2-15/16"	2-1/8"	
Phoenix	2-5/8"	2-7/16"	2-3/16"	
Prague	2-5/8"	2-7/16"	2-3/16"	2-11/16"
Sora	4 1/8"	2 1/4"	2 3/16"	
Troy	2-5/8"	2-5/16"	2-1/16"	

DEADBOLTS

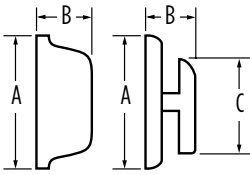

Design	A	B	C
GD 1471 Uptown Interior	2-5/8"	1-3/8"	1-21/32"
GD 1471 Uptown Exterior	2-5/8"	9/16"	N/A
GD 1471 Crosstown	3-9/16"	1-3/8 "	1-21/32"
GD 1471 Downtown Interior	2-5/8"	1-7/16"	1-21/32"
GD 1471 Downtown Exterior	2-5/8"	1/2"	N/A
GD 1471 Hometown	2-21/32"	1- 1/8"	1-21/32"
GD 1471 Intown	3-9/16"	1-3/8"	1-21/32"
GD 1471 Midtown Interior	2-5/8 po	1-7/16 po	1-21/32 po
GD 1471 Midtown Exterior	2-5/8 po	1/2 po	N/A
GCD 9471 Interior	2-9/16"	1-5/32"	1-13/16"
GCD 9471 Exterior	2-5/8"	1-1/16"	
GCD 9571 Interior	2-9/16"	1-5/32"	1-13/16"
GCD 9571 Exterior	3"	1-5/8"	
GD 9471	2-9/16"	1-1/16"	1-3/4"
SSD 9471 Round Interior	2-17/32"	1-13/32"	1-11/16"
SSD 9471 Round Exterior	2-17/32"	15/16"	N/A
SSD 9471 Square Interior	2-17/32"	1-13/32"	1-11/16"
SSD 9471 Square Exterior	2-19/32"	15/16"	N/A

POCKET DOORLOCKS

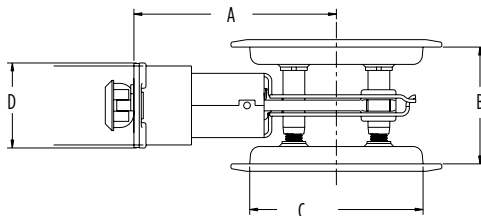

Design	A	B	C	D
Passage	2-3/8"	1-3/8" or 1-3/4"	2-1/8"	1"
Privacy	2-3/8"	1-3/8" or 1-3/4"	2-1/8"	1"

Intro

Electronics

Box Pack

Visual Pack

Padlocks

Parts



ELEMENTS

box pack

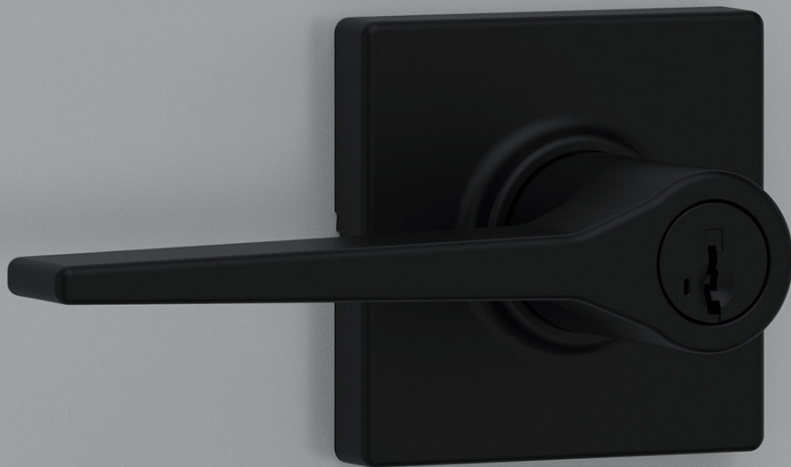

ELEMENTS

Intro

Electronics

Box Pack

Visual Pack

Padlocks

Parts

HANDLESETS GROUP A	Function	GAC 9771 Single Cylinder
	List Price	\$196

AMADOR	Finish Availability	GAC9771 AMD
	15 Satin Nickel	9GAC97710-006
	26D Satin Chrome	9GAC97710-007
	514 Matte Black	9GAC97710-009
Case Quantity		6

15 Satin Nickel	9GAC97710-011	KW
514 Matte Black	9GAC97710-010	
Case Quantity		6

HANDLESETS GROUP B	Function	GAC 9771 Single Cylinder
	List Price	\$167

KINGSWAY	Finish Availability	GAC9771 K
	11P Venetian Bronze	9GAC97710-014
	15 Satin Nickel	9GAC97710-002
	26D Satin Chrome	9GAC97710-004
Case Quantity		6

15 Satin Nickel	9GAC97710-013	KW
26D Satin Chrome	9GAC97710-012	
Case Quantity		6

NOTE: All box pack handlesets are ordered LESS INTERIOR PACK (LIP). Interior packs must be ordered separately.

ELEMENTS

Interior Packs	Function	GAC/GLC9675 Single Cylinder	GAC/GLC9675 Single Cylinder
	List Price	\$63	\$63

ALFINI	Finish Availability		
15	Satin Nickel	9GLC96750-030	

BRETON	Finish Availability		SQUARE ROSE	ROUND ROSE
	15	Satin Nickel	9GLC96750-046	9GLC96750-050
26	Polished Chrome	9GLC96750-048	9GLC96750-051	
26D	Satin Chrome	9GLC96750-049	--	
514	Matte Black	9GLC96750-047	9GLC96750-064	

CASEY	Finish Availability		SQUARE ROSE	ROUND ROSE
	15	Satin Nickel	9GLC96750-060	9GLC96750-062
514	Matte Black	9GLC96750-061	9GLC96750-063	

FAIRFAX	Finish Availability		
15	Satin Nickel	9GAC96750-037	
26D	Satin Chrome	9GAC96750-038	

HENLEY	Finish Availability		
15	Satin Nickel	9GLC96750-058	
514	Matte Black	9GLC96750-059	

Intro

Electronics

Box Pack

Visual Pack

Parts

Parts

HANDLESETS INTERIOR PACK

ELEMENTS

Interior Packs	Function	GAC/GLC9675 Single Cylinder	GAC/GLC9675 Single Cylinder
	List Price	\$63	\$63

HOLLIS	Finish Availability	SQUARE ROSE	ROUND ROSE
15	Satin Nickel	9GLC96750-052	9GLC96750-056
26	Polished Chrome	9GLC96750-055	9GLC96750-057
26D	Satin Chrome	9GLC96750-054	--
514	Matte Black	9GLC96750-053	9GLC96750-065

KIM	Finish Availability		
15	Satin Nickel	9GLC96750-032	
26D	Satin Chrome	9GLC96750-033	

MAVEN	Finish Availability	SQUARE ROSE	ROUND ROSE
15	Satin Nickel	9GAC96750-047	9GAC96750-045
514	Matte Black	9GAC96750-048	9GAC96750-046

TRISTAN	Finish Availability	LEFT HANDED	RIGHT HANDED
15	Satin Nickel	9GLC96750-042	9GLC96750-043
514	Matte Black	9GLC96750-044	9GLC96750-045

Intro

Electronics

Box Pack

Visual Pack

Padlocks

Parts

ELEMENTS

LEVERS GROUP A	Function	101 Hall/Closet	331 Bed/Bath	535 Keyed Entry	12 Inactive
	List Price	\$76	\$85	\$129	\$48

BRETON - SQUARE ROSE	Finish Availability	GLC 101 BRNL	GLC 331 BRNL	GLC 535 BRNL	GLC 12 BRNL
	15 Satin Nickel	9GLC1010-062	9GLC3310-062	9GLC5350-090	9GLC120-092
	26 Polished Chrome	9GLC1010-064	9GLC3310-064	9GLC5350-092	9GLC120-094
	26D Satin Chrome	9GLC1010-065	9GLC3310-065	9GLC5350-093	9GLC120-095
	514 Matte Black	9GLC1010-063	9GLC3310-063	9GLC5350-091	9GLC120-093
Case Quantity		12	12	12	6

BRETON - ROUND ROSE	Finish Availability	GLC 101 BRNL	GLC 331 BRNL	GLC 535 BRNL	GLC 12 BRNL
	15 Satin Nickel	9GLC1010-066	9GLC3310-066	9GLC5350-113	9GLC120-096
	26 Polished Chrome	9GLC1010-067	9GLC3310-067	9GLC5350-114	9GLC120-097
	514 Matte Black	9GLC1010-092	9GLC3310-089	9GLC5350-115	9GLC120-119
Case Quantity		12	12	12	6

Intro

Electronics

Box Pack

Visual Pack

Padlocks

Parts

ELEMENTS

LEVERS GROUP B	Function	101 Hall/Closet - 20 Min Fire Rated	331 Bed/Bath	535 Keyed Entry	12 Inactive
	List Price	\$67	\$76	\$119	\$40

ALFINI	Finish Availability	GLC 101 AI	GLC 331 AI	GLC 535 AI	GLC 12 AI
	15 Satin Nickel	9GLC1010-048	9GLC3310-050	9GLC5350-082	9GLC120-071
	Case Quantity	12	12	12	6

KIM	Finish Availability	GLC 101 KML FD	GLC 331 KML	GLC 535 KML	GLC 12 KML
	15 Satin Nickel	9GLC1010-051	9GLC3310-053	9GLC5350-084	9GLC120-072
	26D Satin Chrome	9GLC1010-050	9GLC3310-052	9GLC5350-086	9GLC120-070
	Case Quantity	12	12	12	6

CASEY - SQUARE ROSE	Finish Availability	GLC 101 CSL FD	GLC 331 CSL	GLC 535 CSL	GLC 12 CSL
	15 Satin Nickel	9GLC1010-085	9GLC3310-085	9GLC5350-109	9GLC120-115
	26 Polished Chrome	9GLC1010-093	9GLC3310-091	9GLC5350-119	9GLC120-121
	514 Matte Black	9GLC1010-086	9GLC3310-086	9GLC5350-110	9GLC120-116
	Case Quantity	12	12	12	6

CASEY - ROUND ROSE	Finish Availability	GLC 101 CSL FD	GLC 331 CSL	GLC 535 CSL	GLC 12 CSL
	15 Satin Nickel	9GLC1010-087	9GLC3310-087	9GLC5350-111	9GLC120-117
	26 Polished Chrome	9GLC1010-094	9GLC3310-092	9GLC5350-120	9GLC120-122
	514 Matte Black	9GLC1010-088	9GLC3310-088	9GLC5350-112	9GLC120-118
	Case Quantity	12	12	12	6

HENLEY	Finish Availability	GLC 101 HYL	GLC 331 HYL	GLC 535 HYL	GLC 12 HYL
	15 Satin Nickel	9GLC1010-083	9GLC3310-083	9GLC5350-107	9GLC120-113
	514 Matte Black	9GLC1010-084	9GLC3310-084	9GLC5350-108	9GLC120-114
	Case Quantity	12	12	12	6

ELEMENTS

LEVERS GROUP B	Function	101 Hall/Closet - 20 Min Fire Rated	331 Bed/Bath	535 Keyed Entry	12 Inactive
	List Price	\$67	\$76	\$119	\$40

HOLLIS - SQUARE ROSE	Finish Availability	GLC 101 HSL FD	GLC 331 HSL	GLC 535 HSL	GLC 12 HSL
	15 Satin Nickel	9GLC1010-075	9GLC3310-075	9GLC5350-101	9GLC120-105
	26 Polished Chrome	9GLC1010-078	9GLC3310-078	9GLC5350-104	9GLC120-108
	26D Satin Chrome	9GLC1010-077	9GLC3310-077	9GLC5350-103	9GLC120-107
	514 Matte Black	9GLC1010-076	9GLC3310-076	9GLC5350-102	9GLC120-106
Case Quantity		12	12	12	6

HOLLIS - ROUND ROSE	Finish Availability	GLC 101 HSL FD	GLC 331 HSL	GLC 535 HSL	GLC 12 HSL
	15 Satin Nickel	9GLC1010-079	9GLC3310-079	9GLC5350-116	9GLC120-109
	26 Polished Chrome	9GLC1010-080	9GLC3310-080	9GLC5350-117	9GLC120-110
	514 Matte Black	9GLC1010-089	9GLC3310-090	9GLC5350-118	9GLC120-120
	Case Quantity		12	12	12

LEVERS GROUP B	Function	101 Hall/Closet	331 Bed/Bath	535 Keyed Entry	12 Inactive LH	12 Inactive RH
	List Price	\$67	\$76	\$119	\$40	\$40

TRISTAN	Finish Availability	GLC 101 TSL	GLC 331 TSL	GLC 535 TSL	GLC 12 TSL LH	GLC TSL RH
	15 Satin Nickel	9GLC1010-060	9GLC3310-060	9GLC5350-088	9GLC120-088	9GLC120-089
	514 Matte Black	9GLC1010-061	9GLC3310-061	9GLC5350-089	9GLC120-090	9GLC120-091
	Case Quantity		12	12	12	6

Intro

Electronics

Box Pack

Visual Pack

Padlocks

Parts

BOX PACK

ELEMENTS

KNOBS GROUP A	Function	101 Hall/Closet	331 Bed/Bath	531 Keyed Entry	12 Inactive
	List Price	\$53	\$62	\$89	\$35

MAVEN - SQUARE ROSE	Finish Availability		GAC 101 MNK	GAC 331 MNK	GAC 531 MNK	GAC 12 MNK
	15	Satin Nickel	9GAC1010-048	9GAC3310-041	9GAC5310-085	9GAC120-037
	514	Matte Black	9GAC1010-049	9GAC3310-042	9GAC5310-086	9GAC120-038
	Case Quantity		12	12	12	6

MAVEN - ROUND ROSE	Finish Availability		GAC 101 MNK	GAC 331 MNK	GAC 531 MNK	GAC 12 MNK
	15	Satin Nickel	9GAC1010-046	9GAC3310-039	9GAC5310-083	9GAC120-035
	514	Matte Black	9GAC1010-047	9GAC3310-040	9GAC5310-084	9GAC120-036
	Case Quantity		12	12	12	6

KNOBS GROUP B	Function	101 Hall/Closet	331 Bed/Bath	531 Keyed Entry	12 Inactive
	List Price	\$46	\$55	\$82	\$26

FAIRFAX	Finish Availability		GAC 101 F	GAC 331 F	GAC 531 F	GAC 12 F
	15	Satin Nickel	9GAC1010-042	9GAC3310-037	9GAC5310-078	9GAC120-033
	26D	Satin Chrome	9GAC1010-039	9GAC3310-034	9GAC5310-075	9GAC120-030
	Case Quantity		12	12	12	6

15	Satin Nickel			9GAC5310-081	
26D	Satin Chrome			9GAC5310-080	
Case Quantity				12	

Intro

Electronics

Box Pack

Visual Pack



Padlocks



Parts

ELEMENTS

KNOBS GROUP B	Function	101 Hall/Closet	331 Bed/Bath	531 Keyed Entry	12 Inactive
	List Price	\$42	\$51	\$77	\$26

YUKON	Finish Availability		GAC 101 Y	GAC 331 Y	GAC 531 Y	GAC 12 Y
	15	Satin Nickel	9GAC1010-058	9GAC3310-051	9GAC5310-094	9GAC120-040
	26D	Satin Chrome	9GAC1010-059	9GAC3310-052	9GAC5310-096	9GAC120-041
	514	Matte Black	9GAC1010-053	9GAC3310-046	9GAC5310-090	9GAC120-039
	Case Quantity		12	12	12	6

15	Satin Nickel			9GAC5310-095	
26D	Satin Chrome			9GAC5310-097	
514	Matte Black			9GAC5310-091	
Case Quantity				12	

BEVERLY	Finish Availability		GAC 101 B	GAC 331 B	GAC 531 B	GAC 12 B
	26D	Satin Chrome	9GAC1010-035	9GAC3310-030	9GAC5310-082	9GAC120-026 
	Case Quantity		12	12	12	6

Intro

Electronics

Box Pack

Visual Pack

Padlocks

Parts

ELEMENTS

GDC 9471



Finish Availability		GDC 9471 Single Cylinder
15	Satin Nickel	9GDC94710-068
26D	Satin Chrome	9GDC94710-070
514	Matte Black	9GDC94710-085
List Price		\$56
Case Quantity		12

GDC 9471 SQT



Finish Availability		GDC 9471 SQT Single Cylinder	GDC9471 Single Cylinder - 20 Min Fire Rated
15	Satin Nickel	--	9GDC94710-069
26	Polished Chrome	9GDC94710-084	9GDC94710-086
26D	Satin Chrome	--	9GDC94710-071
514	Matte Black	--	9GDC94710-072
List Price		\$64	\$64
Case Quantity		12	12

15	Satin Nickel	--	9GDC94710-082
26D	Satin Chrome	--	9GDC94710-081
514	Matte Black	--	9GDC94710-079
List Price		--	\$64
Case Quantity			12

KW

GDC 9471 RDT



Finish Availability		GDC 9471 RDT Single Cylinder	GDC9471 Single Cylinder - 20 Min Fire Rated
15	Satin Nickel	--	9GDC94710-076
26	Polished Chrome	9GDC94710-077	--
514	Matte Black	--	9GDC94710-078
List Price		\$64	\$64
Case Quantity		12	12

15	Satin Nickel	--	9GDC94710-083
514	Matte Black	--	9GDC94710-080
List Price		--	\$64
Case Quantity			12

KW

Intro

Electronics

Box Pack

Visual Pack

Padlocks

Parts

ELEMENTS

UPCHARGE

KEYING & RESTAMPING CHARGES

- Master Keying - \$19.00
- Construction Keying - \$19.00
- Construction Master Keying - \$23.00
- SmartKey Keyed Alike - \$6.00
- Stamping - Per Key/Cylinder - N/C
- Stamping - Do Not Copy/Duplicate - N/C

ELEMENTS

All Elements product meets ASTM E 331 water penetration testing

HANDLESETS

Door Prep Deadbolt: Cross Bore 2-1/8" or 1-1/2" Edge Bore 1" Latch Face 1" x 2-1/4".

Handle: Cross Bore 2-1/8" Edge Bore 1" Latch Face 1" x 2-1/4"

Backset Deadbolt: Adjustable to 2-3/8" or 2-3/4"
Handle: Adjustable to 2-3/8" or 2-3/4"

Door Thickness 1-3/4" doors standard. 2-1/4" doors optional
Not designed for use on 1-3/8" doors

Cylinder SmartKey standard, see specific product for more WS and KW availability

Faceplate 1" x 2-1/4". Round corner, square corner and drive-in available in box

Strikes Deadbolt: 1-1/8" x 2-3/4"
Round or square radius standard in box
Handle: 2-1/4" full lip
Round or square radius standard in box
Other options available

Bolt Deadbolt: 1"
Handle: 1/2" throw

Door Handling Reversible for right or left-handed doors

ANSI/BHMA A156.5 Grade 3 (for deadbolt)

ADA N/A

UL Fire rating, see specific product for availability

LEVERS

Door Prep Cross Bore 2-1/8" Edge Bore 1" Latch Face 1" x 2-1/4".

Backset Adjustable to 2-3/8" or 2-3/4"
UL 2-3/4" standard 2-3/8" optional

Door Thickness 1-3/8" - 1-3/4" doors standard.
2-1/4" doors optional on GLC 101models

Cylinder SmartKey standard, see specific product for more WS and KW availability

Faceplate 1" x 2-1/4". Round corner, square corner and drive-in available in box

Strikes 2-1/4" full lip. Other options available

Bolt 1/2" throw. Nickel plated

Door Handling Reversible for right or left-handed doors

ANSI/BHMA A156.2 Grade 3

ADA Functions GLC 101 and GLC 12 satisfy section 4.13.9. ADA requirement

UL Fire rating, see specific product for availability

KNOBS

Door Prep Cross Bore 2-1/8" Edge Bore 1" Latch Face 1" x 2-1/4".

Backset Adjustable to 2-3/8" or 2-3/4"
UL 2-3/4" standard 2-3/8" optional

Door Thickness 1-3/8" - 1-3/4" doors standard. 2-1/4" doors optional. 2-1/4" doors optional on GAC 101 models only

Cylinder SmartKey standard, see specific product for more WS and KW availability

Faceplate 1" x 2-1/4". Round corner, square corner and drive-in available in box

Strikes 2-1/4" full lip. Other options available.

Bolt 1/2" throw. Nickel plated

Door Handling Reversible for right or left-handed doors

ANSI/BHMA A156.2 Grade 3

ADA N/A

UL Fire rating, see specific product for availability

DEADBOLTS

Door Prep Cross Bore 2-1/8" Edge Bore 1" Latch Face 1" x 2-1/4".

Backset Adjustable to 2-3/8" or 2-3/4"

Door Thickness 1-3/8" - 1-3/4" doors standard

Cylinder SmartKey standard, see specific product for more WS and KW availability

Faceplate 1" x 2-1/4". Round corner, square corner and drive-in available in box

Strikes 1-1/8" x 2-3/4"

Bolt 1" throw

Door Handling Reversible for right or left-handed doors

ANSI/BHMA A156.5 Grade 3

ADA Interior turn piece meets 4.13.9 ADA requirements

UL Fire rating, see specific product for availability

ELEMENTS

HANDLESETS

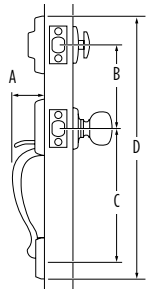

Design	A	B	C	D
Amador	2-3/32"	5-1/2"	9-11/32"	17-15/32"
Brentwood	2-1/32"	5-1/2"	8-13/32"	18-1/16"
Henley	2-5/32"	5-1/2"	8-13/32"	17-5/16"
Kingsway	2-7/32"	5-1/2"	8-13/32"	17-7/16"

LEVERS

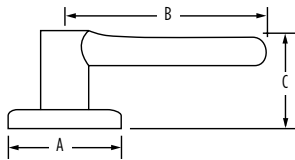

Design	A	B	C	C (Keyed)
Alfini	2-5/8"	3-3/4"	2-1/4"	2-5/8"
Belmont	2-5/8"	3-3/4"	2-1/4"	2-5/8"
Breton Square	2-5/8"	4"	2-7/16"	
Breton Round	2-5/8"	4"	2-7/16"	
Henley	2-5/8"	4-3/32"	2-9/16"	2-19/32"
Hollis Square	2-5/8"	4-4/32"	2-12/32"	
Hollis Round	2-5/8"	4-4/32"	2-12/32"	
Kim	2-5/8"	3-5/8"	1-15/16"	2-5/8"
Tristan	2-5/8"	4-7/16"	1-7/8"	2-7/16"

KNOBS

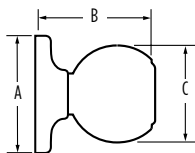

Design	A	B	C	C (Keyed)
Beverly	2-19/32"	2-7/16"	2"	
Fairfax	2-5/8"	2-11/32"	1-15/16"	
Maven Square	2-5/8"	2-7/16"	2-3/32"	2-23/32"
Maven Round	2-5/8"	2-7/16"	2-3/32"	2-23/32"
Yukon	2-5/8"	2-23/32"	1-7/8"	

DEADBOLTS

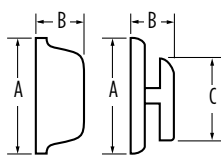

Design	A	B	C
GDC 9471	2-1/2"	1-1/8"	1-3/4"
GDC 9471 Square	2-1/2"	1-1/8"	1-3/4"
GDC 9471 Round	2-1/2"	1-1/8"	1-3/4"

A close-up photograph of a modern, silver-colored door handle with a lock mechanism. The handle is mounted on a white door. The lock is a cylindrical knob that can be turned. The background is slightly blurred, showing a glimpse of a room with a chair and a table.

SAFE LOCK

box pack

Intro

Electronics

Box Pack

Visual Pack

Padlocks

Parts

DAYLON	Function	1000 Hall/Closet	1000 Hall/Closet - 20 Min Fire Rated	1002 Hall/Closet - 3 Hr Fire Rated	3000 Bed/Bath	7000 Inactive
	List Price	\$56	\$56	\$78	\$62	\$35

DAYLON - SQUARE ROSE	Finish Availability	SL1000 DAL	SL1000 DAL	SL1002 DAL	SL3000 DAL	SL7000 DAL
	15 Satin Nickel	--	9SL10000-077	9SL10020-015	9SL30000-074	9SL70000-052
	26 Polished Chrome	9SL10000-078	--	--	9SL30000-075	9SL70000-053
	26D Satin Chrome	--	9SL10000-079	--	9SL30000-076	9SL70000-054
	514 Matte Black	--	9SL10000-081	9SL10020-020	9SL30000-078	9SL70000-056
Case Quantity		20	20	20	20	20

DAYLON - ROUND ROSE	Finish Availability	SL1000 DAL	SL1000 DAL	SL1002 DAL	SL3000 DAL	SL7000 DAL
	15 Satin Nickel	--	9SL10000-082	--	9SL30000-079	9SL70000-057
	26 Polished Chrome	9SL10000-083	--	--	9SL30000-080	9SL70000-058
	26D Satin Chrome	--	9SL10000-123	9SL10020-021	9SL30000-098	9SL70000-078
	514 Matte Black	--	9SL10000-084	--	9SL30000-081	9SL70000-059
Case Quantity		20	20	20	20	20

GRAPEVINE	Function	1000 Hall/Closet	3000 Bed/Bath	7000 Inactive
	List Price	\$48	\$56	\$26

GRAPEVINE	Finish Availability	SL1000 GV	SL3000 GV	SL7000 GV
	15 Satin Nickel	9SL10000-051	9SL30000-051	9SL70000-039
	Case Quantity	20	20	20

LAYTON	Function	1000 Hall/Closet	1002 Hall/Closet - 3 Hr Fire Rated	3000 Bed/Bath	7000 Inactive Left Handed	7000 Inactive Right Handed
	List Price	\$50	\$72	\$58	\$28	\$28

LAYTON	Finish Availability	SL1000 LY	SL1002 LY	SL3000 LY	SL7000 LY LH	SL7000 LY RH
	15 Satin Nickel	9SL10000-045	9SL10020-016	9SL30000-045	9SL70000-033	9SL70000-034
	26D Satin Chrome	9SL10000-049	9SL10020-017	9SL30000-049	9SL70000-037	9SL70000-038
	Case Quantity	20	20	20	20	20

WESTLEY	Function	1000 Hall/Closet	3000 Bed/Bath	7000 Inactive
	List Price	\$56	\$62	\$34

WESTLEY	Finish Availability	SL1000 WTL	SL3000 WTL	SL7000 WTL
	15 Satin Nickel	9SL10000-066	9SL30000-065	9SL70000-047
	26 Polished Chrome	9SL10000-076	9SL30000-073	9SL70000-051
	26D Satin Chrome	9SL10000-068	9SL30000-066	9SL70000-048
	Case Quantity	20	20	20

WINSTON	Function	1000 Hall/Closet - 20 Min Fire Rated	1002 Hall/Closet - 3 Hr Fire Rated	3000 Bed/Bath	5000 Keyed Entry	7000 Inactive
	List Price	\$47	\$69	\$54	\$69	\$25

WINSTON	Finish Availability	SL1000 WI	SL1002 WI	SL3000 WI	SL5000 WI	SL7000 WI
	15 Satin Nickel	9SL10000-058	9SL10020-018	9SL30000-057	9SL50000-097	9SL70000-043
	26D Satin Chrome	9SL10000-061	9SL10020-019	9SL30000-060	9SL50000-100	9SL70000-044
	514 Matte Black	9SL10000-161	9SL10020-057	9SL30000-106	9SL50000-132	9SL70000-107
	Case Quantity	20	20	20	20	20

KW

Intro

Electronics

Box Pack

Visual Pack

Padlocks

Parts

REGINA	Function	1000 Hall/Closet	3000 Bed/Bath	5000 Keyed Entry	7000 Inactive
	List Price	\$29	\$33	\$44	\$20

REGINA	Finish Availability	SK1000RG	SK3000RG	SK5000RG	SK7000RG
	15 Satin Nickel	9SK10000-040	9SK30000-040	9SK50000-057	9SK70000-022
	26D Satin Chrome	9SK10000-044	9SK30000-044	9SK50000-059	9SK70000-024
Case Quantity		30	30	30	30

KW

Intro
Electronics
Box Pack
Visual Pack
Padlocks
Parts

SD9102	Finish Availability		9102 Deadbolt - 3 Hr Fire Rated	
	15	Satin Nickel	9SD91020-005	
	26D	Satin Chrome	9SD91020-004	
List Price			\$34	
Case Quantity			12	

UPCHARGE

KEYING & STAMPING CHARGES

Master Keying - \$19.00

Construction Keying - \$19.00

Construction Master Keying - \$23.00

SmartKey Keyed Alike - \$6.00

Stamping - Per Key/Cylinder - N/C

Stamping - Do Not Copy/Duplicate - N/C

Intro

Electronics

Box Pack

Visual Pack

Padlocks

Parts

HANDLESETS

Door Prep	Deadbolt: Cross Bore 2-1/8" or 1-1/2" Edge Bore 1" Latch Face 1" x 2-1/4"	Strikes	Deadbolt: 1" x 2-1/4" Square and Radius Corner full lip (5303) Handle: 2-1/4" full lip Square and Radius Corner
Backset	Deadbolt: Adjustable to 2-3/8" or 2-3/4" Handle: Adjustable to 2-3/8" or 2-3/4"	Bolt	Deadbolt: 1" throw Handle: 1/2" throw
Door Thickness	1-3/8" - 1-3/4" doors standard No thick door option	Door Handling	Non-handed
Cylinder	KW 5 pin	ANSI/BHMA	A156.5 Grade 3 Deadbolt
Faceplate	1" x 2-1/4" Square corner or drive-in	ADA	N/A
		UL	N/A

KNOBS

Door Prep	Cross Bore 2-1/8" Edge Bore 1" Latch Face 1" x 2-1/4"	Strikes	2-1/4" full lip. Square and Radius Corner
Backset	Adjustable to 2-3/8" or 2-3/4"	Bolt	1/2" throw
Door Thickness	1-3/8" - 1-3/4" doors standard No thick door option	Door Handling	Non-handed
Cylinder	KW 5 pin	ANSI/BHMA	A156.2 Grade 3
Faceplate	1" x 2-1/4" Square corner or drive-in	ADA	N/A
		UL	Meets UL 3 hour fire rating for all UL functions ULRef # R7860

LEVERS

Door prep	Cross Bore 2-1/8" Edge Bore 1" Latch Face 1" x 2-1/4".	Strikes	2-1/4" full lip. Square and Radius Corner
Backset	Adjustable to 2-3/8" or 2-3/4" UL 2-3/4" standard 2-3/8" optional	Bolt	1/2" throw
Door Thickness	1-3/8" - 1-3/4" doors standard. No thick door option	ANSI/BHMA	A156.2 Grade 3
Cylinder	KW 5 pin	ADA	1000 and 7000 functions satisfy section 4.13.9 ADA requirements
Faceplate	1" x 2-1/4" Square corner	UL	Meets UL 3 hour fire rating for all UL functions. ULRef # R7860. Meets 20-minute with drive-in latch

DEADBOLTS

Door Prep	Single & Double Cylinder: Cross Bore 2-1/8". Edge Bore 1" Latch Face 1" x 2-1/4" One Sided Deadbolt: Half Cross Bore 1-5/8" Edge Bore 1" Latch Face 1" x 2-1/4"	Strikes	1" x 2-1/4" Square and Radius Corner
Backset	Adjustable to 2-3/8" or 2-3/4"	Bolt	1" throw.
Door Thickness	1-3/8" - 1-3/4" doors standard. No thick door option	Door Handling	Non-handed
Cylinder	KW 5 pin	ANSI/BHMA	A156.5 Grade 3
Faceplate	1" x 2-1/4" Specify round corner, square corner or drive-in	ADA	Interior turn piece meets 4.13.9 ADA requirements
		UL	Meets UL 3 hour fire rating for all UL functions. ULRef # 10923

LEVERS

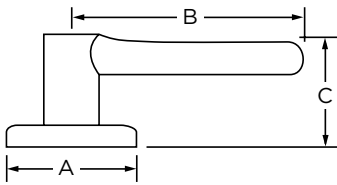

Design	A	B	C	C (Keyed)
Daylon	2-9/16"	4-3/32"	2-5/16"	
Grapevine	2-9/16"	3-3/4"	2-1/2"	2-1/2"
Layton	2-9/16"	3-5/8"	2-3/8"	2-3/8"
Westley	2-9/16"	4-3/32"	2-5/16"	
Winston	2-9/16"	3-5/8"	2-3/8"	2-3/8"

KNOBS

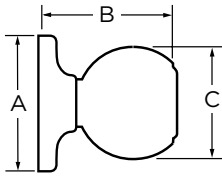

Design	A	B	C
Regina	2-9/16"	2-7/8"	1-3/4"

DEADBOLTS

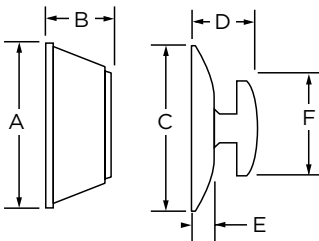

Design	A	B	C	D	E	F
Single Cylinder	2-1/2"	1-1/8"	2-9/16"	3/4"	1/4"	2-1/8"



VISUAL PACK



Intro

Electronics



Box Pack

Visual Pack

Padlocks

Parts

HANDLESETS GROUP A	Function	9471 / 8471 Single Cylinder
	List Price	\$525



	CAERUS	Finish Availability	GLA8471 CRH/HFL
	15	Satin Nickel	9GLA84710-027
	514	Matte Black	9GLA84710-026
			
		Interior	Halifax
	Case Quantity		2

	PRAVA	Finish Availability	GLA8471 PVH/PVL
	15	Satin Nickel	9GLA84710-025
	514 x 15	Matte Black x Satin Nickel	9GLA84710-024
			
		Interior	Prava
	Case Quantity		2

HANDLESETS GROUP B	Function	9471 / 8471 Single Cylinder	8471 Single Cylinder
	List Price	\$471	\$471

SAN CLEMENTE	Finish Availability		GLA8471 SCE/HFL	GA8471 SCE/CBK
	4	Satin Brass	9GLA84710-022	
	15	Satin Nickel	9GLA84710-001	
	18G	Gunmetal	9GLA84710-023	
	514	Matte Black	9GLA84710-002	9GA84710-002
				
	Interior		Halifax	Cambie
	Case Quantity		2	2

VANCOUVER	Finish Availability		GLA8471 VNH/HFL
	514	Matte Black	9GLA84710-005
			
		Interior	Halifax
		Case Quantity	2

PRAGUE	Finish Availability		GLA8471 PGH/PGL
	15	Satin Nickel	9GLA84710-014
	514	Matte Black	9GLA84710-015
			
		Interior	Prague
	Case Quantity		2

Intro

Electronics

Box Pack

Visual Pack

Padlocks

Parts

Intro

Electronics



Box Pack

Visual Pack





Padlocks

Parts



HANDLESETS GROUP C	Function	9471 Single Cylinder
	List Price	\$461



	TAVARIS	Finish Availability	GLA9471 TVH/BRNL
	15	Satin Nickel	9GLA94710-039
	514	Matte Black	9GLA94710-038
			
	Interior		Breton
	Case Quantity		2

HANDLESETS GROUP D	Function	8471 Single Cylinder	8471 Single Cylinder	8471 Single Cylinder
	List Price	\$440	\$440	\$440

	PRESCOTT	Finish Availability	GLA8471 PTH/TC	GLA8471 PTH/KAL	GLA8471 PTH/SEL
	11P	Venetian Bronze	9GLA84710-006		
	15	Satin Nickel	9GLA84710-007		9GLA84710-018
	514	Matte Black	9GLA84710-008	9GLA84710-010	9GLA84710-019
					
Interior		Toluca	Katella	Sedona	
	Case Quantity		2	2	2

HANDLESET MINUS	Function	7771 Handleset Minus
	List Price	\$298

SAN CLEMENTE 	Finish Availability		GLA7771 SCE/HFL
	15	Satin Nickel	9GLA77710-007
	514	Matte Black	9GLA77710-001
			
	Interior		Halifax
Case Quantity		2	

TAVARIS 	Finish Availability		GLA7771 TVH/BRNL
	15	Satin Nickel	9GLA77710-009
			
	Interior		Breton
	Case Quantity		2

PRESCOTT 	Finish Availability		GLA7771 PTH/KAL
	15	Satin Nickel	9GLA77710-010
	514	Matte Black	9GLA77710-011
			
	Interior		Katella
Case Quantity		2	

Intro

HALIFAX LED		Function	101 Hall/Closet	331 Bed/Bath
	15	Satin Nickel	9GLA1010-196	9GLA3310-176
	514	Matte Black	9GLA1010-197	9GLA3310-177
	List Price		\$100	\$117
Case Quantity		4	4	

Electronics

LEVERS GROUP A	Function	101 Hall/Closet	331 Bed/Bath	535 Keyed Entry
	List Price	\$100	\$119	\$173

Box Pack

PRAVA LEVER		Finish Availability	GLA 101 PVL	GLA 331 PVL	GLA 535 PVL
	15	Satin Nickel	9GLA1010-216	9GLA3310-189	9GLA5350-234
	514 x 15	Matte Black x Satin Nickel	9GLA1010-215	9GLA3310-188	9GLA5350-233
	Case Quantity		4	4	4

Visual Pack

Padlocks

Parts



LEVERS GROUP B	Function	101 Hall/Closet	331 Bed/Bath	535 Keyed Entry	12 Inactive
	List Price	\$85	\$103	\$161	\$57

SINGAPORE	Finish Availability	GLA 101 SAL	GLA 331 SAL	GLA 535 SAL	GLA 12 PGL
	15 Satin Nickel	9GLA1010-135	9GLA3310-134	9GLA5350-179	9GLA120-129
	514 Matte Black	9GLA1010-136	9GLA3310-135	9GLA5350-180	9GLA120-130
	Case Quantity	4	4	4	4

LEVERS GROUP C	Function	101 Hall/Closet	331 Bed/Bath	535 Keyed Entry	12 Inactive
	List Price	\$85	\$103	\$161	\$53

HALIFAX	Finish Availability	GLA 101 HFL	GLA 331 HFL	GLA535 HFL	GLA 12 HFL
	4 Satin Brass	9GLA1010-151	9GLA3310-144	9GLA5350-185	9GLA120-137
	18G Gunmetal	9GLA1010-214	9GLA3310-187	9GLA5350-232	--
	Case Quantity	4	4	4	4

PERTH	Finish Availability	GLA 101 PHL	GLA 331 PHL	GLA 535 PHL
	15 Satin Nickel	9GLA1010-163	9GLA3310-156	9GLA5350-197
	514 Matte Black	9GLA1010-164	9GLA3310-157	9GLA5350-198
	Case Quantity	4	4	4

PRAGUE	Finish Availability	GLA 101 PGL	GLA 331 PGL	GLA 535 PGL	GLA 12 PGL
	15 Satin Nickel	9GLA1010-137	9GLA3310-136	9GLA5350-181	9GLA120-131
	514 Matte Black	9GLA1010-138	9GLA3310-137	9GLA5350-182	9GLA120-132
	Case Quantity	4	4	4	4

Intro

Electronics

Box Pack

Visual Pack

Padlocks

Parts

Intro

Electronics

Box Pack

Visual Pack

Padlocks

Parts

LEVERS GROUP C	Function	101 Hall/Closet	331 Bed/Bath	535 Keyed Entry
	List Price	\$85	\$103	\$161

SEDONA	Finish Availability	GLA 101 SEL	GLA 331 SEL	GLA 535 SEL
	4 Satin Brass	9GLA1010-155	9GLA3310-148	9GLA5350-189
	15 Satin Nickel	9GLA1010-153	9GLA3310-146	9GLA5350-187
	514 Matte Black	9GLA1010-154	9GLA3310-147	9GLA5350-188
Case Quantity		4	4	4

TRAFFORD	Finish Availability	GLA 101 TDL	GLA 331 TDL	GLA 535 TDL
	15 Satin Nickel	9GLA1010-159	9GLA3310-152	9GLA5350-193
	514 Matte Black	9GLA1010-160	9GLA3310-153	9GLA5350-194
Case Quantity		4	4	4

LEVERS GROUP D	Function	101 Hall/Closet	331 Bed/Bath	535 Keyed Entry	12 Inactive
	List Price	\$81	\$99	\$153	\$49

HALIFAX	Finish Availability	GLA 101 HFL	GLA 331 HFL	GLA535 HFL	GLA 12 HFL
	11P Venetian Bronze	9GLA1010-062	9GLA3310-061	9GLA5350-091	9GLA120-051
	15 Satin Nickel	9GLA1010-063	9GLA3310-062	9GLA5350-092	9GLA120-052
	26 Polished Chrome	9GLA1010-064	9GLA3310-063	9GLA5350-093	9GLA120-053
	514 Matte Black	9GLA1010-065	9GLA3310-064	9GLA5350-094	9GLA120-054
Case Quantity		4	4	4	4

MILAN	Finish Availability	GLA 101 MIL	GLA331 MIL	GLA 535 MIL	GLA 12 MIL
	15 Satin Nickel	9GLA1010-066	9GLA3310-065	9GLA5350-095	9GLA120-055
	26D Satin Chrome	9GLA1010-067	9GLA3310-066	9GLA5350-096	9GLA120-056
	514 Matte Black	9GLA1010-126	9GLA3310-125	9GLA5350-170	9GLA120-120
Case Quantity		4	4	4	4

LEVERS GROUP D	Function	101 Hall/Closet	331 Bed/Bath	535 Keyed Entry	12 Inactive
	List Price	\$81	\$99	\$153	\$49

KATELLA	Finish Availability	GLA 101 KAL	GLA 331 KAL	GLA 535 KAL	GLA 12 KAL
	15 Satin Nickel	9GLA1010-132	9GLA3310-131	9GLA5350-176	9GLA120-126
	514 Matte Black	9GLA1010-133	9GLA3310-132	9GLA5350-177	9GLA120-127
	Case Quantity	12	12	12	6

LEVERS GROUP D	Function	101 Hall/Closet	331 Bed/Bath	535 Keyed Entry	12 Inactive LH	12 Inactive RH
	List Price	\$81	\$99	\$153	\$49	\$49

TOLUCA	Finish Availability	GLA 101 TC	GLA 331 TC	GLA 535 TC	GLA 12 TC	GLA 12 TC
	11P Venetian Bronze	9GLA1010-053	9GLA3310-052	9GLA5350-076	9GLA120-038	9GLA120-039
	15 Satin Nickel	9GLA1010-050	9GLA3310-049	9GLA5350-071	9GLA120-034	9GLA120-035
	514 Matte Black	9GLA1010-118	9GLA3310-117	9GLA5350-147	9GLA120-111	9GLA120-112
	Case Quantity	4	4	4	4	4

Intro

Electronics

Box Pack

Visual Pack

Padlocks

Parts

Intro

KNOB GROUP A	Function	101 Hall/Closet	331 Bed/Bath	531 Keyed Entry	12 Inactive
	List Price	\$69	\$87	\$144	\$35

Electronics

	PRAGUE	Finish Availability	GLA 101 PGK	GLA 331 PGK	GLA 531 PGK	GLA 12 PGK
	15	Satin Nickel	9GA1010-153	9GA3310-156	9GA5310-211	9GA120-100
	514	Matte Black	9GA1010-154	9GA3310-157	9GA5310-212	9GA120-101
	Case Quantity		4	4	4	4

Box Pack

	SORA	Finish Availability	GLA 101 SOK	GLA 331 SOK	GLA 531 SOK
	514	Matte Black	9GA1010-159	9GA3310-162	9GA5310-219
	Case Quantity		4	4	4

Visual Pack

KNOB GROUP B	Function	101 Hall/Closet	331 Bed/Bath	531 Keyed Entry	12 Inactive
	List Price	\$65	\$83	\$137	\$33

Padlocks

	CAMBIE	Finish Availability	GA 101 CBK	GA 331 CBK	GA 531 CBK	GA 12 CBK
	15	Satin Nickel	9GA1010-147	9GA3310-150	9GA5310-188	9GA120-094
	514	Matte Black	9GA1010-148	9GA3310-151	9GA5310-189	9GA120-095
	Case Quantity		4	4	4	4

Parts

KNOBS GROUP C	Function	101 Hall/Closet	331 Bed/Bath	531 Keyed Entry	12 Inactive
	List Price	\$61	\$79	\$134	\$33

PHOENIX	Finish Availability	GA 101 P	GA 331 P	GA 531 P	GA 12 P
	15 Satin Nickel	9GA1010-011	9GA3310-010	9GA5310-052	9GA120-007
	Case Quantity	4	4	4	4

KNOBS GROUP D	Function	101 Hall/Closet	331 Bed/Bath	531 Keyed Entry	12 Inactive
	List Price	\$52	\$70	\$125	\$27

TROY	Finish Availability	GA 101 T	GA 331 T	GA 531 T	GA 12 T
	15 Satin Nickel	9GA1010-003	9GA3310-003	9GA5310-047	9GA120-002
	26D Satin Chrome	9GA1010-006	9GA3310-006	9GA5310-049	9GA120-004
	514 Matte Black	9GA1010-009	9GA3310-009	9GA5310-051	9GA120-006
	Case Quantity	4	4	4	4

Intro

Electronics

Box Pack

Visual Pack

Padlocks

Parts

CROSTOWN GD1471

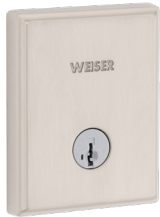

Finish Availability		GD 1471 Single Cylinder
15	Satin Nickel	9GD14710-048
514	Matte Black	9GD14710-047
List Price		\$115
Case Quantity		4

DOWNTOWN GD 1471



Finish Availability		GD 1471 SQT Single Cylinder
4	Satin Brass	9GD14710-039
15	Satin Nickel	9GD14710-017
18G	Gunmetal	9GD14710-058
514	Matte Black	9GD14710-023
List Price		\$115
Case Quantity		4

HOMETOWN GD1471



Finish Availability		GD 1471 Single Cylinder
15	Satin Nickel	9GD14710-046
514	Matte Black	9GD14710-045
List Price		\$115
Case Quantity		4

INTOWN GD 1471



Finish Availability		GD 1471 Single Cylinder
514	Matte Black	9GD14710-044
List Price		\$115
Case Quantity		4



MIDTOWN GD 1471		Finish Availability	GD 1471 Single Cylinder
	15	Satin Nickel	9GD14710-033
	514	Matte Black	9GD14710-034
	List Price		\$115
	Case Quantity		4

UPTOWN GD 1471		Finish Availability	GD 1471 RDT Single Cylinder
	15	Satin Nickel	9GD14710-018
	514	Matte Black	9GD14710-024
	List Price		\$115
	Case Quantity		4

GCD 9471		Finish Availability	GCD 9471 Single Cylinder Square Face Latch	GCD 9471 Single Cylinder Drive-In Latch
	15	Satin Nickel	9GCD94710-050	9GCD94710-049
	514	Matte Black	9GCD94710-055	9GCD94710-054
	List Price		\$106	\$106
	Case Quantity		4	4

GD 9471		Finish Availability	GD 9471 Single Cylinder
	3BR	Lifetime Brass	9GD94710-091
	11P	Venetian Bronze	9GD94710-084
	15	Satin Nickel	9GD94710-087
	26D	Satin Chrome	9GD94710-090
	514	Matte Black	9GD94710-085
	List Price		\$103
Case Quantity		4	

SSD 9471 SQUARE		Finish Availability	SSD 9471 SQT
	15	Satin Nickel	9SSD94710-018
	514	Matte Black	9SSD94710-053
	List Price		\$86
	Case Quantity		4

Intro

Electronics

Box Pack

Visual Pack

Padlocks

Parts

Intro

Electronics

Box Pack

Visual Pack

Padlocks

Parts

CAMBIE		Finish Availability	GACS741	GACS7481
			Deadbolt x Keyed Knob	Deadbolt x Passage Knob
	15	Satin Nickel	9GACS74510-025	
	514	Matte Black	9GACS74810-003	
		List Price	\$189	\$121
		Case Quantity	4	4

TROY		Finish Availability	GSC7451
			Deadbolt x Keyed Knob
	26D	Satin Chrome	9GSC74510-012
		List Price	\$184
		Case Quantity	4

TOLUCA		Finish Availability	GSL7481
			Deadbolt x Passage Lever
	15	Satin Nickel	9GSL74810-001
		List Price	\$155
		Case Quantity	4

ROUND POCKET DOORLOCK



Finish Availability		WR1030 Passage	WR1031 Privacy
15	Satin Nickel	9WR10300-003	9WR10310-003
List Price		\$44	\$48
Case Quantity		6	6

SQUARE POCKET DOORLOCK



Finish Availability		W1030 Passage	W1031 Privacy
11P	Venetian Bronze	9W10300-008	9W10310-016
15	Satin Nickel	9W10300-003	9W10310-010
26D	Satin Chrome	9W10300-011	9W10310-013
List Price		\$44	\$48
Case Quantity		6	6







ELEMENTS

visual pack

ELEMENTS

by **WEISER**

HANDLESETS GROUP A	Function	GLC9471 Single Cylinder	GLC9471 Single Cylinder
	List Price	\$265	\$265

AMADOR	Finish Availability		GLC9471 AMD/CSL	GLC9471 AMD/HSL
	15	Satin Nickel	9GLC94710-020	9GLC94710-022
	514	Matte Black	9GLC94710-021	9GLC94710-023
				
	Interior		Casey	Hollis
	Case Quantity		2	2

HENLEY	Finish Availability		GLC9471 HYH HYL
	15	Satin Nickel	9GLC94710-025
	514	Matte Black	9GLC94710-024
			
	Interior		Henley
	Case Quantity		2

Intro

Electronics

Box Pack

Visual Pack

Padlocks

Parts

ELEMENTS
by **WEISER**

HANDLESETS GROUP B	Function	9471 Single Cylinder	9471 Single Cylinder
	List Price	\$236	\$236

BRENTWOOD	Finish Availability	GLC9471 BDH/BLM	GAC9471 BDH/F
	3 Brass	9GLC94710-005	
	11P Venetian Bronze	9GLC94710-004	
	15 Satin Nickel	9GLC94710-006	9GAC94710-008
	514 Matte Black	9GLC94710-017	
	Interior	Belmont	Fairfax
Case Quantity		2	2

KINGSWAY	Finish Availability	GAC9471 K/F	GAC9471 K/Y
	3BR Lifetime Brass		9GAC94710-001
	11P Venetian Bronze	9GAC94710-003	
	15 Satin Nickel		9GAC94710-007
	26D Satin Chrome		9GAC94710-002
	514 Matte Black		9GAC94710-009
Interior	Fairfax	Yukon	
Case Quantity		2	2

Intro

Electronics

Box Pack

Visual Pack

Padlocks

Parts

ELEMENTS

by **WEISER**

LEVERS GROUP A	Function	101 Hall/Closet	331 Bed/Bath	535 Keyed Entry	12 Inactive
	List Price	\$78	\$87	\$131	\$52

BRETON	Finish Availability	GLC 101 BRNL	GLC 331 BRNL	GLC 535 BRNL	GLC 12 BRNL
	15 Satin Nickel	9GLC1010-068	9GLC3310-068	9GLC5350-094	9GLC120-098
	514 Matte Black	9GLC1010-069	9GLC3310-069	9GLC5350-095	9GLC120-099
	Case Quantity	4	4	4	4

LEVERS GROUP B	Function	101 Hall/Closet	331 Bed/Bath	535 Keyed Entry	12 Inactive
	List Price	\$69	\$78	\$121	\$41

CASEY - SQUARE ROSE	Finish Availability	GLC 101 CSL	GLC 331 CSL	GLC 535 CSL	GLC 12 CSL
	15 Satin Nickel	9GLC1010-071	9GLC3310-071	9GLC5350-097	9GLC120-101
	514 Matte Black	9GLC1010-072	9GLC3310-072	9GLC5350-098	9GLC120-102
	Case Quantity	4	4	4	4

CASEY - ROUND ROSE	Finish Availability	GLC 101 CSL	GLC 331 CSL	GLC 535 CSL	GLC 12 CSL
	15 Satin Nickel	9GLC1010-097	9GLC3310-096	9GLC5350-121	--
	514 Matte Black	9GLC1010-098	9GLC3310-097	9GLC5350-122	--
	Case Quantity	4	4	4	

HENLEY	Finish Availability	GLC 101 HYL	GLC 331 HYL	GLC 535 HYL	GLC 12 HYL
	15 Satin Nickel	9GLC1010-081	9GLC3310-081	9GLC5350-105	9GLC120-111
	514 Matte Black	9GLC1010-082	9GLC3310-082	9GLC5350-106	9GLC120-112
	Case Quantity	4	4	4	4

Intro

Electronics

Box Pack

Visual Pack

Padlocks

Parts

ELEMENTS
by/for WEISER

LEVERS GROUP B	Function	101 Hall/Closet	331 Bed/Bath	535 Keyed Entry	12 Inactive
	List Price	\$69	\$78	\$121	\$41

HOLLIS	Finish Availability	GLC 101 HSL	GLC 331 HSL	GLC 535 HSL	GLC 12 HSL
	15 Satin Nickel	9GLC1010-073	9GLC3310-073	9GLC5350-099	9GLC120-103
	514 Matte Black	9GLC1010-074	9GLC3310-074	9GLC5350-100	9GLC120-104
Case Quantity		4	4	4	4

KIM	Finish Availability	GLC 101 KML	GLC 331 KML	GLC 535 KML	GLC 12 KML
	26D Satin Chrome	9GLC1010-043	9GLC3310-043	9GLC5350-060	9GLC120-061
	Case Quantity	6	6	6	4

LEVERS GROUP C	Function	101 Hall/Closet	331 Bed/Bath	535 Keyed Entry	12 Inactive LH	12 Inactive RH
	List Price	\$62	\$72	\$99	\$39	\$39

BELMONT	Finish Availability	GLC 101 BLM	GLC 331 BLM	GLC 535 BLM	GLC 12 BLM LH	GLC 12 BLM RH
	3 Brass	9GLC1010-014	9GLC3310-014	9GLC5350-031	9GLC120-013	9GLC120-018
	15 Satin Nickel	9GLC1010-017	9GLC3310-017	9GLC5350-034	9GLC120-016	9GLC120-021
	26D Satin Chrome	9GLC1010-018	9GLC3310-018	9GLC5350-035	9GLC120-017	9GLC120-022
	514 Matte Black	9GLC1010-057	9GLC3310-057	9GLC5350-074	9GLC120-082	9GLC120-083
Case Quantity		6	6	6	4	4

Intro

Electronics

Box Pack

Visual Pack

Padlocks

Parts

ELEMENTS

by/for WEISER

KNOBS GROUP A	Function	101 Hall/Closet	331 Bed/Bath	531 Keyed Entry
	List Price	\$55	\$65	\$91

MAVEN - SQUARE ROSE	Finish Availability	GAC 101 MNK	GAC 331 MNK	GAC 531 MNK
	15 Satin Nickel	9GAC1010-050	9GAC3310-043	9GAC5310-087
	514 Matte Black	9GAC1010-051	9GAC3310-044	9GAC5310-088
	Case Quantity	12	12	12

MAVEN - ROUND ROSE	Finish Availability	GAC 101 MNK	GAC 331 MNK	GAC 531 MNK
	15 Satin Nickel	9GAC1010-054	9GAC3310-047	9GAC5310-092
	514 Matte Black	9GAC1010-055	9GAC3310-048	9GAC5310-093
	Case Quantity	12	12	12

KNOBS GROUP B	Function	101 Hall/Closet	331 Bed/Bath	531 Keyed Entry	12 Inactive
	List Price	\$48	\$57	\$84	\$28

FAIRFAX	Finish Availability	GAC 101 F	GAC 331 F	GAC 531 F	GAC 12 F
	15 Satin Nickel	9GAC1010-033	9GAC3310-028	9GAC5310-069	9GAC120-024
	26D Satin Chrome	9GAC1010-007	9GAC3310-007	9GAC5310-067	9GAC120-005
	Case Quantity	6	6	6	6

KNOBS GROUP C	Function	101 Hall/Closet	331 Bed/Bath	531 Keyed Entry	12 Inactive
	List Price	\$44	\$53	\$79	\$36

YUKON	Finish Availability	GAC 101 Y	GAC 331 Y	GAC 531 Y	GAC 12 Y
	3 Brass	9GAC1010-009	9GAC3310-009	9GAC5310-068	9GAC120-007
	15 Satin Nickel	9GAC1010-011	9GAC3310-011	9GAC5310-046	9GAC120-008
	26D Satin Chrome	9GAC1010-013	9GAC3310-013	9GAC5310-048	9GAC120-009
	514 Matte Black	9GAC1010-052	9GAC3310-045	9GAC5310-089	--
	Case Quantity	6	6	6	6

ELEMENTS

by/for WEISER

Intro

Electronics

Box Pack

Visual Pack

Padlocks

Parts

GDC 9471		Finish Availability	GDC 9471 Single Cylinder
	3BR	Lifetime Brass	9GDC94710-061
	11P	Venetian Bronze	9GDC94710-058
	15	Satin Nickel	9GDC94710-059
	26D	Satin Chrome	9GDC94710-060
	514	Matte Black	9GDC94710-087
	List Price		
Case Quantity			6

GDC 9471 SQT		Finish Availability	GDC9471 SQT Single Cylinder
	15	Satin Nickel	9GDC94710-062
	514	Matte Black	9GDC94710-063
	List Price		\$66
	Case Quantity		6

GDC 9471 RDT		Finish Availability	GDC9471 RDT Single Cylinder
	15	Satin Nickel	9GDC94710-073
	26D	Satin Chrome	9GDC94710-075
	514	Matte Black	9GDC94710-074
	List Price		\$66
	Case Quantity		6



ELEMENTS
by **WEISER**

BELMONT	Finish Availability	GAC7451	
		Deadbolt x Keyed Lever	
	15	Satin Nickel	9GLCS74510-002
	List Price		\$133
	Case Quantity		4

CASEY	Finish Availability	GLC7451	
		Deadbolt x Keyed Lever	
	15	Satin Nickel	9GLCS74510-003
	514	Matte Black	9GLCS74510-005
	List Price		\$158
Case Quantity		4	

HOLLIS	Finish Availability	GLC7451	
		Deadbolt x Keyed Lever	
	15	Satin Nickel	9GLCS74510-004
	514	Matte Black	9GLCS74510-006
	List Price		\$158
Case Quantity		4	

Intro

Electronics

Box Pack

Visual Pack

Padlocks

Parts

ELEMENTS

by/for WEISER

Intro

Electronics

Box Pack

Visual Pack

Padlocks

Parts

MAVEN		Finish Availability	GAC7451
			Deadbolt x Keyed Knob
	15	Satin Nickel	9GACS74510-026
	514	Matte Black	9GACS74510-027
	List Price		\$128
Case Quantity		4	

FAIRFAX		Finish Availability	GAC7481
			Deadbolt x Passage Knob
	26D	Satin Chrome	9GACS74810-001
	List Price		\$102
	Case Quantity		4

FAIRFAX		Finish Availability	GAC7451
			Deadbolt x Keyed Knob
	15	Satin Nickel	9GACS74510-018
	List Price		\$114
	Case Quantity		4

YUKON		Finish Availability	GAC7451
			Deadbolt x Keyed Knob
	15	Satin Nickel	9GACS74510-022
	26D	Satin Chrome	9GACS74510-021
	514	Matte Black	9GACS74510-028
	List Price		\$112
	Case Quantity		4



SAFE LOCK

visual pack

SAFE LOCK

BRANTON X WESTLEY	Function	SH1100 Single Cylinder	SH1100 Single Cylinder
	List Price	\$200	\$200

BRANTON	Finish Availability		SH1100BRNHXWTL	SH1100BRNHXREL
	15	Satin Nickel	9SH11000-022	9SH11000-025
	514	Matte Black		9SH11000-026
	Interior			
	Case Quantity		2	2

DAYTONA X REGINA	Function	SH1100 Single Cylinder	SH1100 Single Cylinder
	List Price	\$177	\$191

DAYTONA	Finish Availability		SH1100DTXRG	SH1100DTXLY
	3	Polished Brass	9SH11000-008	
	11P	Venetian Bronze		9SH11000-016
	15	Satin Nickel	9SH11000-010	9SH11000-017
	514	Matte Black	9SH11000-024	
Interior				
Case Quantity			2	2

Intro

Electronics

Box Pack

Visual Pack

Parts

SAFE LOCK

REMINY	Function	1000 Hall/Closet	3000 Bed/Bath	5000 Keyed Entry	7000 Inactive
	List Price	\$58	\$64	\$80	\$37

DAYLON	Finish Availability	SL1000DAL	SL3000DAL	SL5000DAL	SL7000DAL
	15 Satin Nickel	9SL10000-080	9SL30000-077	9SL50000-067	9SL70000-055
	514 Matte Black	9SL10000-085	9SL30000-082	9SL50000-068	9SL70000-060
	Case Quantity	6	6	6	4

REMINY	Finish Availability	SL1000REL	SL3000REL	SL5000REL	SL7000REL
	15 Satin Nickel	9SL10000-119	9SL30000-093	9SL50000-118	9SL70000-073
	514 Matte Black	9SL10000-120	9SL30000-094	9SL50000-119	9SL70000-074
	Case Quantity	6	6	6	4

WESTLEY	Finish Availability	SL1000WTL	SL3000WTL	SL5000WTL	SL7000WTL
	15 Satin Nickel	9SL10000-072	9SL30000-071	9SL50000-065	9SL70000-049
	Case Quantity	6	6	6	4

Intro

Electronics

Box Pack

Visual Pack

Parts

SAFE LOCK

LAYTON	Function	1000 Hall/Closet	3000 Bed/Bath	5000 Keyed Entry	7000 Inactive LH	7000 Inactive RH
	List Price	\$52	\$60	\$75	\$30	\$30

LAYTON	Finish Availability	SL1000LY	SL3000LY	SL5000LY	SL7000LY	SL7000LY
	11P Venetian Bronze	9SL10000-033	9SL30000-033	9SL50000-026	9SL70000-021	9SL70000-022
	15 Satin Nickel	9SL10000-034	9SL30000-034	9SL50000-027	9SL70000-023	9SL70000-024
	514 Matte Black	9SL10000-115	9SL30000-092	9SL50000-117	9SL70000-068	9SL70000-069
	Case Quantity	6	6	6	4	4

GRAPEVINE	Function	1000 Hall/Closet	3000 Bed/Bath	5000 Keyed Entry	7000 Inactive
	List Price	\$50	\$58	\$72	\$28

GRAPEVINE	Finish Availability	SL1000GV	SL3000GV	SL5000GV	SL7000GV
	11P Venetian Bronze	9SL10000-025	9SL30000-025	9SL50000-019	9SL70000-013
	15 Satin Nickel	9SL10000-023	9SL30000-023	9SL50000-017	9SL70000-011
	514 Matte Black	9SL10000-114	9SL30000-091	9SL50000-116	9SL70000-067
	Case Quantity	6	6	6	4

Intro

Electronics

Box Pack

Visual Pack

Parts

SAFE LOCK

WINSTON GROUP A	Function	1000 Hall/Closet	3000 Bed/Bath	5000 Keyed Entry	7000 Inactive
	List Price	\$58	\$64	\$80	\$37

WINSTON	Finish Availability	SL1000WI	SL3000WI	SL5000WI	SL7000WI
	15 Satin Nickel	9SL10000-112	9SL30000-089	9SL50000-114	9SL70000-065
	514 Matte Black	9SL10000-113	9SL30000-090	9SL50000-115	9SL70000-066
	Case Quantity	6	6	6	4

WINSTON GROUP B	Function	1000 Hall/Closet	3000 Bed/Bath	5000 Keyed Entry	7000 Inactive
	List Price	\$49	\$56	\$71	\$27

WINSTON	Finish Availability	SL1000WI	SL3000WI	SL5000WI	SL7000WI
	15 Satin Nickel	9SL10000-028	9SL30000-028	9SL50000-022	9SL70000-016
	26D Satin Chrome	9SL10000-027	9SL30000-027	9SL50000-021	9SL70000-015
	Case Quantity	6	6	6	4

SAFE LOCK

MEZO GROUP A	Function	1000 Hall/Closet	3000 Bed/Bath	5000 Keyed Entry
	List Price	\$37	\$42	\$55

MEZO	Finish Availability	SK1000MZK	SK3000MZK	SK5000MZK
	15 Satin Nickel	9SK10000-071	9SK30000-070	9SK50000-081
	514 Matte Black	9SK10000-072	9SK30000-071	9SK50000-082
	Case Quantity	6	6	6

REGINA GROUP B	Function	1000 Hall/Closet	3000 Bed/Bath	5000 Keyed Entry	7000 Inactive
	List Price	\$32	\$36	\$49	\$22

REGINA	Finish Availability	SK1000RG	SK3000RG	SK5000RG	SK7000RG
	3 Polished Brass	9SK10000-023	9SK30000-023	9SK50000-017	9SK70000-011
	11P Venetian Bronze	9SK10000-026	9SK30000-026	9SK50000-020	9SK70000-014
	15 Satin Nickel	9SK10000-025	9SK30000-025	9SK50000-019	9SK70000-013
	26D Satin Chrome	9SK10000-024	9SK30000-024	9SK50000-018	9SK70000-012
	514 Matte Black	9SK10000-054	9SK30000-054	9SK50000-065	9SK70000-025
	Case Quantity	6	6	6	4

Intro

Electronics

Box Pack

Visual Pack

Parts

SAFE LOCK

DEADBOLT	Finish Availability	SD9100 Single Cylinder	SD9100 Single Cylinder
	3 Brass	9SD91000-011	
	11P Venetian Bronze		9SD91000-015
	15 Satin Nickel		9SD91000-013
	26D Satin Chrome	9SD91000-012	
	514 Matte Black		9SD91000-042
	List Price		\$41
Case Quantity		6	6

COMBO PACK	Finish Availability	SC60000RG
	15 Satin Nickel	9SC60000-030
	26D Satin Chrome	9SC60000-031
	514 Matte Black	9SC60000-032
	List Price	\$72
	Case Quantity	6

CONTRACTOR 6 PACK	Finish Availability	SC60000RG
	15 Satin Nickel	9SC60000-033
	514 Matte Black	9SC60000-034
	List Price	\$184
	Case Quantity	2

PADLOCKS



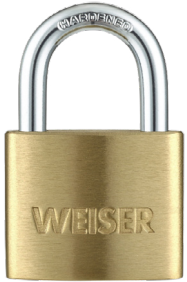

Outdoor - Everyday

Brass Padlock

- Solid brass body for smoother long-term operation
- Hardened Steel Shackle: 1/4" (6.3mm) diameter shackle provides superior resistance against cutting and sawing
- 5-pin cylinder for more key combinations and improved pick resistance vs typical 4-pin cylinders

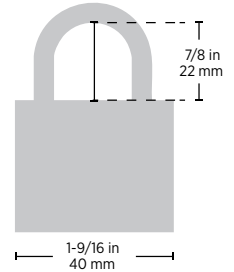

Part Number	Description	List Price	Visual Pack Size	Shelf Pack Size	Master Case Quantity
9GPL0260-320	1-9/16" Brass Padlock 7/8" Shackle	\$20.00	1 Padlock Keyed	6	24
9GPL0260-321	1-9/16" Brass Padlock 7/8" Shackle	\$37.00	2 Padlocks Keyed Alike	6	24
9GPL0260-322	1-9/16" Brass Padlock 7/8" Shackle	\$71.00	4 Padlocks Keyed Alike	4	16



Outdoor - Everyday

Brass Padlock

- Solid brass body for smoother long-term operation
- Hardened Steel Shackle: 1/4" (6.3mm) diameter shackle provides superior resistance against cutting and sawing
- 5-pin cylinder for more key combinations and improved pick resistance vs typical 4-pin cylinders

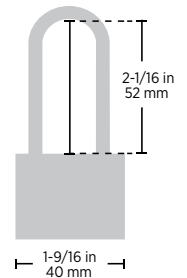

Part Number	Description	List Price	Visual Pack Size	Shelf Pack Size	Master Case Quantity
9GPL0260-327	1-9/16" Brass Padlock 2-1/16" Shackle	\$24.00	1 Padlock Keyed	6	24
9GPL0260-328	1-9/16" Brass Padlock 2-1/16" Shackle	\$44.00	2 Padlocks Keyed Alike	6	24
9GPL0260-329	1-9/16" Brass Padlock 2-1/16" Shackle	\$84.00	4 Padlocks Keyed Alike	4	16

Intro

Electronics

Box Pack

Visual Pack

Padlocks

Parts

Intro

Electronics

Box Pack

Visual Pack

Padlocks

Parts

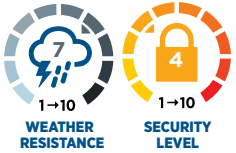

Outdoor - Everyday

Aluminum Padlock

- Lightweight aluminum body with a corrosion-resistant polished finish
- Hardened Steel Shackle: 1/4" (6.3mm) diameter shackle provides superior resistance against cutting and sawing
- 5-pin cylinder for more key combinations and improved pick resistance vs typical 4-pin cylinders

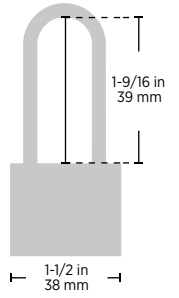

Part Number	Description	List Price	Visual Pack Size	Shelf Pack Size	Master Case Quantity
9GPL0260-425	1-1/2" Aluminum Padlock 1-9/16" Shackle	\$18.00	1 Padlock Keyed	4	24
9GPL0260-426	1-1/2" Aluminum Padlock 1-9/16" Shackle	\$34.00	2 Padlocks Keyed Alike	4	24
9GPL0260-427	1-1/2" Aluminum Padlock 1-9/16" Shackle	\$65.00	4 Padlocks Keyed Alike	4	24

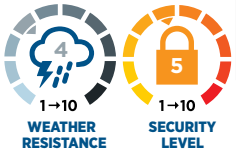
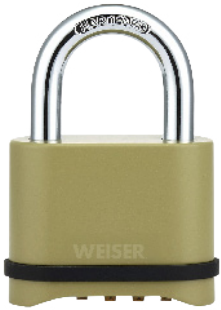

Outdoor - Everyday

Zinc Combination Padlock

- Solid metal body with rubber bumper - Built to handle bumps and rough handling
- Hardened steel shackle: Thick 5/16" (8mm) shackle helps resist cutting and sawing attempts
- 10,000 possible combinations: Set your own 4-digit combination and reset as needed

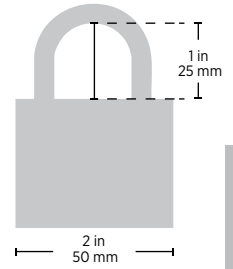

Part Number	Description	List Price	Visual Pack Size	Shelf Pack Size	Master Case Quantity
9GPL0260-200	2" Zinc Combination Padlock 1" Shackle	\$30.00	1 Padlock Resetttable	6	24

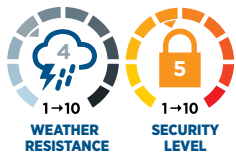

Outdoor - Everyday

Zinc Padlock

- Solid metal body with rubber bumper - Built to handle bumps and rough handling
- Hardened steel shackle: Thick 5/16" (8mm) shackle helps resist cutting and sawing attempts
- 10,000 possible combinations: Set your own 4-digit combination and reset as needed

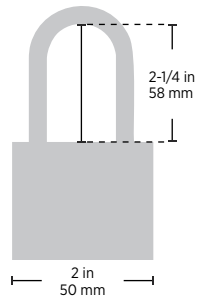

Part Number	Description	List Price	Visual Pack Size	Shelf Pack Size	Master Case Quantity
9GPL0260-201	2" Zinc Combination Padlock 2-1/4" Shackle	\$33.00	1 Padlock Resetttable	6	24

Intro

Electronics

Box Pack

Visual Pack

Padlocks

Parts

Intro



Outdoor - Everyday

Laminated Steel Padlock

- Layered laminated steel body with a protective bumper base
- Hardened steel shackle: Thick 1/4in (6.2mm) shackle helps resist cutting and sawing attempts
- 4-pin cylinder: Delivers smooth, dependable everyday security for light-duty applications

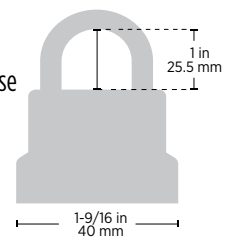

Part Number	Description	List Price	Visual Pack Size	Shelf Pack Size	Master Case Quantity
9GPL0260-100	1-9/16" Laminated Steel Padlock 1" Shackle	\$22.00	1 Padlock Keyed	4	24
9GPL0260-101	1-9/16" Laminated Steel Padlock 1" Shackle	\$40.00	2 Padlocks Keyed Alike	4	24
9GPL0260-102	1-9/16" Laminated Steel Padlock 1" Shackle	\$76.00	4 Padlocks Keyed Alike	4	16

Electronics

Box Pack

Visual Pack

Padlocks

Parts

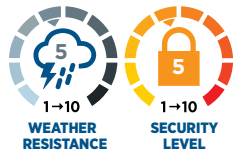

Outdoor - Everyday

Laminated Steel Padlock

- Layered laminated steel body with a protective bumper base
- Hardened steel shackle: Thick 1/4in (6.2mm) shackle helps resist cutting and sawing attempts
- 4-pin cylinder: Delivers smooth, dependable everyday security for light-duty applications

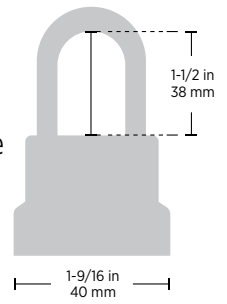

Part Number	Description	List Price	Visual Pack Size	Shelf Pack Size	Master Case Quantity
9GPL0260-104	1-9/16" Laminated Steel Padlock 1-1/2" Shackle	\$23.00	1 Padlock Keyed	4	24
9GPL0260-105	1-9/16" Laminated Steel Padlock 1-1/2" Shackle	\$42.00	2 Padlocks Keyed Alike	4	24
9GPL0260-106	1-9/16" Laminated Steel Padlock 1-1/2" Shackle	\$78.00	4 Padlocks Keyed Alike	4	16



Outdoor - Everyday

Laminated Steel Padlock

- Layered laminated steel body with a protective bumper base
- Hardened steel shackle: Thick 1/4in (7mm) shackle helps resist cutting and sawing attempts
- 4-pin cylinder: Delivers smooth, dependable everyday security for light-duty applications

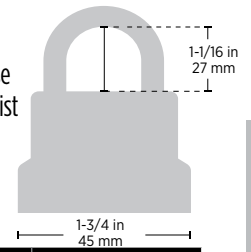

Part Number	Description	List Price	Visual Pack Size	Shelf Pack Size	Master Case Quantity
9GPL0260-120	1-3/4" Laminated Steel Padlock 1-1/16" Shackle	\$24.00	1 Padlock Keyed	4	24
9GPL0260-121	1-3/4" Laminated Steel Padlock 1-1/16" Shackle	\$45.00	2 Padlocks Keyed Alike	4	24
9GPL0260-122	1-3/4" Laminated Steel Padlock 1-1/16" Shackle	\$86.00	4 Padlocks Keyed Alike	4	16



Outdoor - Everyday

Laminated Steel Padlock

- Layered laminated steel body with a protective bumper base
- Hardened steel shackle: Thick 1/4in (7mm) shackle helps resist cutting and sawing attempts
- 4-pin cylinder: Delivers smooth, dependable everyday security for light-duty applications

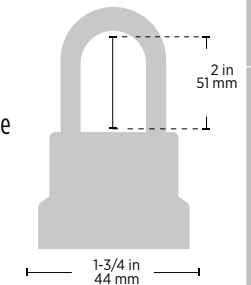

Part Number	Description	List Price	Visual Pack Size	Shelf Pack Size	Master Case Quantity
9GPL0260-124	1-3/4" Laminated Steel Padlock 1-1/16" Shackle	\$25.00	1 Padlock Keyed	4	24
9GPL0260-125	1-3/4" Laminated Steel Padlock 1-1/16" Shackle	\$47.00	2 Padlocks Keyed Alike	4	24
9GPL0260-126	1-3/4" Laminated Steel Padlock 1-1/16" Shackle	\$91.00	4 Padlocks Keyed Alike	4	16

Intro

Electronics

Box Pack

Visual Pack

Padlocks

Parts

Intro

Electronics

Box Pack

Visual Pack

Padlocks

Parts



Outdoor - Everyday

Locker Lock

- No-key convenience: Combination access means no keys to carry, lose, or replace
- Hardened steel shackle: The 5/16in (7.6mm) diameter shackle provides superior resistance against cutting and sawing
- Locker-friendly size: Compact design fits common lockers and tight spaces

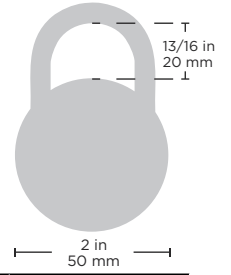

Part Number	Description	List Price	Visual Pack Size	Shelf Pack Size	Master Case Quantity
9GPL0260-800	2" Combination Dial Lock - Black	\$24.00	1 Combination Dial Lock	6	12
9GPL0260-804	2" Combination Dial Lock - Blue & Green	\$45.00	2 Combination Dial Lock	6	12
9GPL0260-806	2" Combination Dial Lock - Red, Blue, Black & Green	\$86.00	4 Combination Dial Lock	6	12



Outdoor - Professional

SmartKey Laminated Steel Padlock

- Featuring SmartKey re key technology that lets you quickly match multiple locks to one key in seconds, making it ideal for crews, rental properties and homeowners managing shared access
- Boron-carbide shackle: Premium, super-hard shackle material for significantly improved cut and saw resistance vs hardened steel

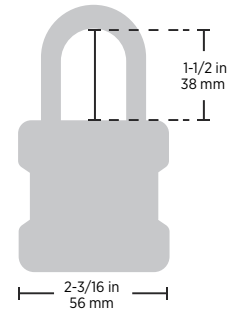

Part Number	Description	List Price	Visual Pack Size	Shelf Pack Size	Master Case Quantity
9GPL0260-040	2-3/16" Laminated Steel SmartKey Padlock 1-1/2" Shackle	\$48.00	1 Padlock Keyed	4	8
9GPL0260-041	2-3/16" Laminated Steel SmartKey Padlock 1-1/2" Shackle	\$86.00	2 Padlocks Keyed Alike	4	8
9GPL0260-042	2-3/16" Laminated Steel SmartKey Padlock 1-1/2" Shackle	\$164.00	4 Padlocks Keyed Alike	4	8

Outdoor - Professional

SmartKey Laminated Steel Padlock

- Featuring SmartKey re key technology that lets you quickly match multiple locks to one key in seconds, making it ideal for crews, rental properties and homeowners managing shared access
- Boron-carbide shackle: Premium, super-hard shackle material for significantly improved cut and saw resistance vs hardened steel

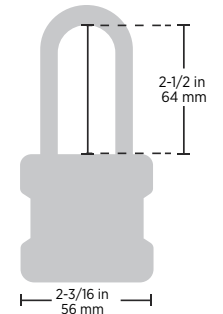

Part Number	Description	List Price	Visual Pack Size	Shelf Pack Size	Master Case Quantity
9GPL0260-046	2-3/16" Laminated Steel SmartKey Padlock 2-1/2" Shackle	\$50.00	1 Padlock Keyed	4	8
9GPL0260-047	2-3/16" Laminated Steel SmartKey Padlock 2-1/2" Shackle	\$90.00	2 Padlocks Keyed Alike	4	8
9GPL0260-048	2-3/16" Laminated Steel SmartKey Padlock 2-1/2" Shackle	\$170.00	4 Padlocks Keyed Alike	4	8

Intro

Electronics

Box Pack

Visual Pack

Padlocks

Parts

Intro



Electronics



Box Pack



Visual Pack

Padlocks

Parts

Outdoor - Professional

SmartKey Laminated Steel Padlock

- Featuring SmartKey re key technology that lets you quickly match multiple locks to one key in seconds, making it ideal for crews, rental properties and homeowners managing shared access
- Boron-carbide shackle: Premium, super-hard shackle material for significantly improved cut and saw resistance vs hardened steel

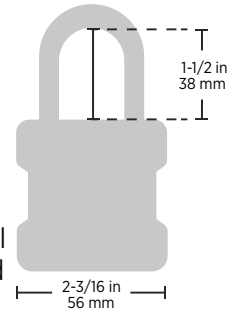

Part Number	Description	List Price	Visual Pack Size	Shelf Pack Size	Master Case Quantity
9GPL0260-043	2-3/16" Laminated Steel SmartKey Padlock with cover and 1-1/2" Shackle	\$54.00	1 Padlock Keyed	4	8
9GPL0260-044	2-3/16" Laminated Steel SmartKey Padlock with cover and 1-1/2" Shackle	\$98.00	2 Padlocks Keyed Alike	4	8
9GPL0260-045	2-3/16" Laminated Steel SmartKey Padlock with cover and 1-1/2" Shackle	\$184.00	4 Padlocks Keyed Alike	4	8



Travel

TSA Combination Padlock

- Set-your-own combination - choose your own code so there are no keys to lose
- TSA inspection access: TSA screeners can open and relock with a master key during inspection
- Durable metal body: Built to handle baggage impacts and everyday travel wear

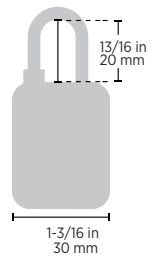

Part Number	Description	List Price	Visual Pack Size	Shelf Pack Size	Master Case Quantity
9GPL0260-701	1-3/16" TSA Combination Padlock	\$22.00	1 Combination Padlock	4	24
9GPL0260-702	1-3/16" TSA Combination Padlock	\$41.00	2 Combination Padlocks	4	24



Travel

TSA Combination Padlock

- Set-your-own combination - choose your own code so there are no keys to lose
- TSA inspection access: TSA screeners can open and relock with a master key during inspection
- Durable metal body: Built to handle baggage impacts and everyday travel wear

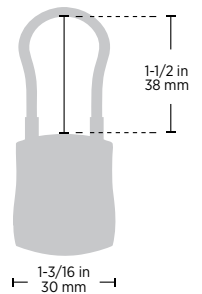

Part Number	Description	List Price	Visual Pack Size	Shelf Pack Size	Master Case Quantity
9GPL0260-720	1-3/16" TSA Combination Padlock	\$23.00	1 Combination Padlock	4	24
9GPL0260-721	1-3/16" TSA Combination Padlock	\$43.00	2 Combination Padlocks	4	24

Intro

Electronics

Box Pack

Visual Pack

Padlocks

Parts

Intro



Key Storage

Combination Lock Box

- Real estate and contractor access control: Leave keys on-site for showings and vendors
- Weather-resistant cover: Helps protect the dials from moisture and debris for reliable outdoor use
- Padded back to ensure the door is not scratched when mounted

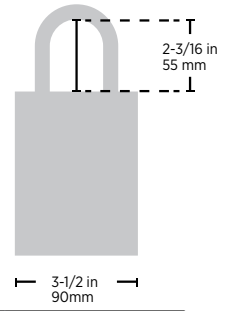

Electronics

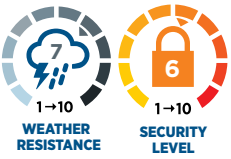

Part Number	Description	List Price	Visual Pack Size	Shelf Pack Size	Master Case Quantity
9GPL0260-601	3-1/2" Combination Portable Lock Box	\$72.00	1 Combination Portable Lock Box	6	24
9GPL0260-602	3-1/2" Combination Portable Lock Box	\$140.00	2 Combination Portable Lock Box	6	24

Box Pack

Visual Pack

Padlocks

Parts



Bicycle Storage

Combination Cable Lock

- Keyless access with 4-dial combination that eliminates the need to carry keys
- 4' length is ideal for short stops and everyday use
- Bike-friendly coating: Outer jacket helps reduce scratching on frames
- Outdoor-ready build: Made to handle routine exposure to rain and humidity

Part Number	Description	List Price	Visual Pack Size	Shelf Pack Size	Master Case Quantity
9GPL0260-900	4' Comb Bicycle Cable Lock 5/16" diameter cable	\$20.00	1 Combination Padlock	4	40

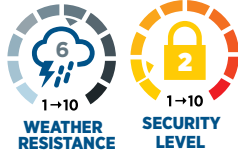

Bicycle Storage

Combination Cable Lock

- Keyless access with 4-dial combination that eliminates the need to carry keys
- 5' length is ideal for short stops and everyday use
- Bike-friendly coating: Outer jacket helps reduce scratching on frames
- Outdoor-ready build: Made to handle routine exposure to rain and humidity

Part Number	Description	List Price	Visual Pack Size	Shelf Pack Size	Master Case Quantity
9GPL0260-902	5' Comb Bicycle Cable Lock 1/2" diameter cable	\$25.00	1 Combination Padlock	4	24

Intro

Electronics

Box Pack

Visual Pack

Padlocks

Parts

Intro



Bicycle Storage

Keyed Cable Lock

- 5-pin cylinder for more key combinations and improved pick resistance vs typical 4-pin cylinders
- 6' length is ideal for short stops and everyday use
- Bike-friendly coating: Outer jacket helps reduce scratching on frames
- Outdoor-ready build: Made to handle routine exposure to rain and humidity

Part Number	Description	List Price	Visual Pack Size	Shelf Pack Size	Master Case Quantity
9GPL0260-905	6ft Keyed Bicycle Cable Lock 5/8" diameter cable	\$39.00	1 Keyed Cable Lock	4	24

Electronics

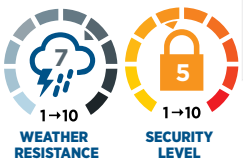

Box Pack



Bicycle Storage

High Security Keyed U-Lock

- High Security U-Lock delivers motorcycle-grade (ART4 certified) bike security in a compact, commuter-friendly package
- A rigid U-lock structure and thick 5/8" hardened steel shackle resist cutting, sawing, and leveraging attacks
- Featuring a 7-pin cylinder that provides strong everyday security

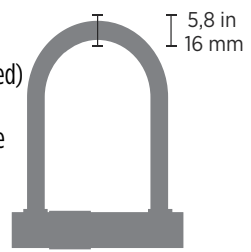

Part Number	Description	List Price	Visual Pack Size	Shelf Pack Size	Master Case Quantity
9GPL0260-940	High Security U-Lock	\$70.00	1 Keyed U-Lock	2	12

Visual Pack

Padlocks



Parts



Bicycle Storage

Folding Combination Lock

- Keyless access: 4-dial combination eliminates the need for keys
- Hardened steel links resist cutting and leveraging better than cable
- Bike-friendly contact points: Coated surfaces help reduce frame scuffs

Part Number	Description	List Price	Visual Pack Size	Shelf Pack Size	Master Case Quantity
9GPL0260-980	3' High Security Combination Folding Lock	\$69.00	1 Folding Lock	2	12

Intro

Electronics

Box Pack



Visual Pack

Padlocks



Parts

PARTS







SMARTKEY

	PART NUMBER	DESCRIPTION	QUANTITY	LIST PRICE
	800004-355	SmartKey Key Blanks	Box/50	\$135.00
	900009-101	SmartKey Cut Key	1	\$5.00
	800004-607	SmartKey Keys - 4 Keys Keyed Alike	4	\$11.00
	84282-001	SmartKey Key Keyed to 23155 - 4 Sets of 2 Keys Keyed Alike	8	\$22.00
	820231-001	Key Control Deadbolt - Control Key Blank	Each	\$5.50
	900009-103	Key Control Deadbolt - Control Key Cut Key	1	\$7.00

PIN & TUMBLER

	PART NUMBER	DESCRIPTION	QUANTITY	LIST PRICE
	800000-125	WR5 P&T Keys	Box/50	\$135.00
	900009-104	WR5 P&T Cut Key	1	\$5.00
	84282-002	WR5 P&T Keys - 2 Keys Keyed Alike	2	\$5.50
	83741-001	KW1 P&T Keys - 2 Keys Keyed Alike	2	\$5.50
	900009-102	KW1 P&T Cut Key	1	\$5.00
	810000-462	Safe Lock Key Blanks	Box/50	\$135.00
	810000-434	Safe Lock Keys - 2 Keys Keyed Alike	2	\$5.50

SMARTKEY TOOLS

	PART NUMBER	DESCRIPTION	QUANTITY	LIST PRICE
	820062-001	Carded VP Rekey Kit (4 silver/2 brass Keys)	Each	\$31.00
	83260-001	SmartKey Reset Cradle	Each	\$52.00
	83282-003	SmartKey Learn Tool	Each	\$4.00
	800004-351	SmartKey Learn Tool	Bag/10	\$9.00
	81087-001	Emergency Tool for All Privacy Function Locksets - Elements and Safelock	Box/100	\$52.00
	83805-001	Emergency Tool for Sora Knob	Bag/5	\$4.00
	83805-002	Emergency Tool for Sora Knob	Bag/100	\$78.00
	83258-001	Reversible Lever Hex Wrench (3/32")	Each	\$6.00

Intro

Electronics



Box Pack

Visual Pack





Padlocks

Parts

SMARTKEY CYLINDERS

	PART NUMBER	COMPATIBILITY	FINISH	QUANTITY	LIST PRICE
	800004-527	GCD9471 Deadbolt with 2 Keys	Satin Nickel	Each	\$77.00
	800004-528	GCD9471 Deadbolt with 2 Keys	Polished Chrome	Each	\$77.00
	800004-529	GCD9471 Deadbolt with 2 Keys	Satin Chrome	Each	\$77.00
	800004-531	GCD9471 Deadbolt with 2 Keys	Matte Black	Each	\$77.00
	820028-002	Elements Deadbolt & Elements Handleset with 2 Keys	Brass	Each	\$32.00
	820028-004	Elements Deadbolt & Elements Handleset with 2 Keys	Satin Nickel	Each	\$32.00
	820028-007	Elements Deadbolt & Elements Handleset with 2 Keys	Satin Chrome	Each	\$32.00
	820028-006	Elements Deadbolt & Elements Handleset with 2 Keys	Polished Chrome	Each	\$32.00
	820028-009	Elements Deadbolt & Elements Handleset with 2 Keys	Matte Black	Each	\$32.00

SMARTKEY PLUGS

	PART NUMBER	COMPATIBILITY	FINISH	QUANTITY	LIST PRICE
	83025-002	GD1471 Deadbolt & 8771 Handleset with 2 Keys	Gold	Each	\$30.00
	83025-001	GD1471 Deadbolt & 8771 Handleset with 2 Keys	Silver	Each	\$30.00
	83025-004	GD1471 Deadbolt & 8771 Handleset with 2 Keys	Gunmetal	Each	\$30.00
	83025-003	GD1471 Deadbolt & 8771 Handleset with 2 Keys	Black	Each	\$30.00
	820280-001	GD/SSD 9471 Deadbolt, 9771 Handleset, Aura, Halo with 2 Keys	Gold	Each	\$30.00
	820280-003	GD/SSD 9471 Deadbolt, 9771 Handleset, Aura, Halo with 2 Keys	Bronze	Each	\$30.00
	820280-002	GD/SSD 9471 Deadbolt, 9771 Handleset, Aura, Halo with 2 Keys	Silver	Each	\$30.00
	820280-004	GD/SSD 9471 Deadbolt, 9771 Handleset, Aura, Halo with 2 Keys	Black	Each	\$30.00
	800004-381	Knob/Lever/SmartCode Lever with 2 Keys	Gold	Each	\$30.00
	800004-384	Knob/Lever/SmartCode Lever with 2 Keys	Bronze	Each	\$30.00
	800004-382	Knob/Lever/SmartCode Lever with 2 Keys	Silver	Each	\$30.00
	800004-385	Knob/Lever/SmartCode Lever with 2 Keys	Black	Each	\$30.00
	84270-001	SmartCode Keypad/Touchpad, Powerbolt 3 with 2 Keys	Black	Each	\$30.00
	84270-002	SmartCode Keypad/Touchpad, Powerbolt 3 with 2 Keys	Silver	Each	\$30.00

Intro

Electronics







Box Pack

Visual Pack

Padlocks

Parts

PIN & TUMBLER CYLINDERS & PLUGS

	PART NUMBER	COMPATIBILITY	FINISH	QUANTITY	LIST PRICE
	820313-001	WR5 Pin & Tumbler Plug - GD/SSD 9471 Deadbolt & 9771 Pin & Tumbler Handleset with 2 Keys	Gold	Each	\$32.00
	820313-003	WR5 Pin & Tumbler Plug - GD/SSD 9471 Deadbolt & 9771 Pin & Tumbler Handleset with 2 Keys	Silver	Each	\$32.00
	820313-008	WR5 Pin & Tumbler Plug - GD/SSD 9471 Deadbolt & 9771 Pin & Tumbler Handleset with 2 Keys	Black	Each	\$32.00
	83742-001	WR5 Pin & Tumbler Full Cylinder Body - 9771 Pin & Tumbler Handleset with 2 Keys	Satin Nickel	Each	\$32.00
	83742-002	WR5 Pin & Tumbler Full Cylinder Body - 9771 Pin & Tumbler Handleset with 2 Keys	Matte Black	Each	\$32.00
	820312-001	KW1 Pin & Tumbler Plug - GD/SSD 9471 Deadbolt & 9771 Pin & Tumbler Handleset with 2 Keys	Gold	Each	\$32.00
	820312-003	KW1 Pin & Tumbler Plug - GD/SSD 9471 Deadbolt & 9771 Pin & Tumbler Handleset with 2 Keys	Silver	Each	\$32.00
	820312-008	KW1 Pin & Tumbler Plug - GD/SSD 9471 Deadbolt & 9771 Pin & Tumbler Handleset with 2 Keys	Black	Each	\$32.00
	84356-001	KW1 Pin & Tumbler Full Cylinder Body - Elements by Weiser Electronic Deadbolt with 1 Key	Silver	Each	\$32.00
	84356-002	KW1 Pin & Tumbler Full Cylinder Body - Elements by Weiser Electronic Deadbolt with 1 Key	Black	Each	\$32.00
	810000-432	KW1 Pin & Tumbler- Safe Lock 1100 Handlesets & 9100 Deadbolts with 2 Keys	Black	Each	\$32.00
	810000-433	KW1 Pin & Tumbler- Safe Lock 1100 Handlesets & 9100 Deadbolts with 2 Keys	Silver	Each	\$32.00
	810000-430	KW1 Pin & Tumbler- Safe Lock Regina Knob with 2 Keys	Black	Each	\$32.00
	810000-431	KW1 Pin & Tumbler- Safe Lock Regina Knob with 2 Keys	Silver	Each	\$32.00
	810000-461	KW1 Pin & Tumbler- Safe Lock Levers with 2 Keys	Silver	Each	\$32.00

Intro

Electronics





Box Pack

Visual Pack

Padlocks

Parts

6-WAY ADJUSTABLE DEADBOLT LATCH

	PART NUMBER	COMPATIBILITY		FINISH	QUANTITY	LIST PRICE
	820317-001	8771 Handlesets & 1471 Deadbolts		Satin Nickel	Each	\$26.00
	820317-002	8771 Handlesets & 1471 Deadbolts		Polished Chrome	Each	\$26.00
	820317-005	8771 Handlesets & 1471 Deadbolts		Gunmetal	Each	\$26.00
	820317-004	8771 Handlesets & 1471 Deadbolts		Matte Black	Each	\$26.00
	83750-001	1471 Deadbolts	20 Minute Fire Rated	Satin Nickel	Each	\$29.00
	83750-002	1471 Deadbolts	20 Minute Fire Rated	Polished Chrome	Each	\$29.00
	83750-003	1471 Deadbolts	20 Minute Fire Rated	Matte Black	Each	\$29.00
	820288-004	9771 Handlesets & 9471/9571 Deadbolts		Brass	Each	\$26.00
	820288-002	9771 Handlesets & 9471/9571 Deadbolts		Satin Nickel	Each	\$26.00
	820288-001	9771 Handlesets & 9471/9571 Deadbolts		Polished Chrome	Each	\$26.00
	820288-007	9771 Handlesets & 9471/9571 Deadbolts		Matte Black	Each	\$26.00
	83708-001	9471/9571 Deadbolts	20 Minute Fire Rated	Satin Nickel	Each	\$29.00
	83708-002	9471/9571 Deadbolts	20 Minute Fire Rated	Polished Chrome	Each	\$29.00
	83708-003	9471/9571 Deadbolts	20 Minute Fire Rated	Matte Black	Each	\$29.00
	820310-001	9771 Handlesets & 9471/9571 Deadbolts	Visual Pack	Satin Nickel	Each	\$28.00
	820310-002	9771 Handlesets & 9471/9571 Deadbolts	Visual Pack	Satin Chrome	Each	\$28.00



SQUARE CORNER ADJUSTABLE LATCH

	PART NUMBER	COMPATIBILITY		FINISH	QUANTITY	LIST PRICE
	83709-001	9471/9571 Deadbolts	3 Hour Fire Rated	Satin Nickel	Each	\$32.00
	83709-002	9471/9571 Deadbolts	3 Hour Fire Rated	Satin Chrome	Each	\$32.00
	83709-003	9471/9571 Deadbolts	3 Hour Fire Rated	Matte Black	Each	\$32.00

5" DEADBOLT LATCH

	PART NUMBER	COMPATIBILITY		FINISH	QUANTITY	LIST PRICE
	820046-001	9771 Handlesets & 9471 Deadbolts		Brass	Each	\$28.00
	820046-003	9771 Handlesets & 9471 Deadbolts		Polished Chrome	Each	\$28.00
	820046-007	9771 Handlesets & 9471 Deadbolts		Matte Black	Each	\$28.00

ELECTRONIC DEADBOLT LATCH

	PART NUMBER	COMPATIBILITY		FINISH	QUANTITY	LIST PRICE
	84245-001	SmartCode Keypad/Touchpad, Aura, Halo/Halo Touch - 4-Way Adjustable Latch	20 Minute Fire Rated	Matte Black	Each	\$29.00
	84245-002	SmartCode Keypad/Touchpad, Aura, Halo/Halo Touch - 4-Way Adjustable Latch	20 Minute Fire Rated	Satin Nickel	Each	\$29.00
	84245-003	SmartCode Keypad/Touchpad, Aura, Halo/Halo Touch - 4-Way Adjustable Latch	20 Minute Fire Rated	Polished Chrome	Each	\$29.00
	84357-001	Elements Keypad/Powerbolt3 - 4-Way Adjustable Latch		Brass	Each	\$22.00
	84357-004	Elements Keypad/Powerbolt3 - 4-Way Adjustable Latch		Venetian Bronze	Each	\$22.00
	84357-002	Elements Keypad/Powerbolt3 - 4-Way Adjustable Latch		Satin Nickel	Each	\$22.00
	84357-003	Elements Keypad/Powerbolt3 - 4-Way Adjustable Latch		Polished Chrome	Each	\$22.00
	84357-005	Elements Keypad/Powerbolt3 - 4-Way Adjustable Latch		Matte Black	Each	\$22.00

Intro

Electronics





Box Pack

Visual Pack

Padlocks

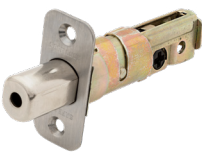
Parts

SAFELOCK DEADBOLT LATCH

	PART NUMBER	COMPATIBILITY		FINISH	QUANTITY	LIST PRICE
	810000-386	1100 Handlesets & 9100 Deadbolts - Square Corner Adjustable Latch		Brass	Each	\$22.00
	810000-387	1100 Handlesets & 9100 Deadbolts - Square Corner Adjustable Latch		Satin Nickel	Each	\$22.00
	810000-390	1100 Handlesets & 9100 Deadbolts - Square Corner Adjustable Latch		Satin Chrome	Each	\$22.00
	810000-389	1100 Handlesets & 9100 Deadbolts - Square Corner Adjustable Latch		Matte Black	Each	\$22.00
	810000-381	1100 Handlesets & 9100 Deadbolts - Radius Corner Adjustable Latch		Brass	Each	\$22.00
	810000-382	1100 Handlesets & 9100 Deadbolts - Radius Corner Adjustable Latch		Satin Nickel	Each	\$22.00
	810000-385	1100 Handlesets & 9100 Deadbolts - Radius Corner Adjustable Latch		Satin Chrome	Each	\$22.00
	810000-384	1100 Handlesets & 9100 Deadbolts - Radius Corner Adjustable Latch		Matte Black	Each	\$22.00
	810000-394	1100 Handlesets & 9100 Deadbolts - Drive-In Adjustable Latch		N/A	Each	\$22.00
	810000-445	9100 Deadbolts - Square Corner Adjustable Latch	3 Hour Fire Rated	Satin Nickel	Each	\$28.00
	810000-446	9100 Deadbolts - Square Corner Adjustable Latch	3 Hour Fire Rated	Satin Chrome	Each	\$28.00
	810000-447	9100 Deadbolts - Square Corner Adjustable Latch	3 Hour Fire Rated	Matte Black	Each	\$28.00
	810000-442	9100 Deadbolts - Radius Corner Adjustable Latch	3 Hour Fire Rated	Satin Nickel	Each	\$28.00
	810000-443	9100 Deadbolts - Radius Corner Adjustable Latch	3 Hour Fire Rated	Satin Chrome	Each	\$28.00
	810000-444	9100 Deadbolts - Radius Corner Adjustable Latch	3 Hour Fire Rated	Matte Black	Each	\$28.00

Intro

Electronics



Box Pack

Visual Pack



Padlocks

Parts



6-WAY ADJUSTABLE PLAIN LATCH & KIT

	PART NUMBER	COMPATIBILITY		FINISH	QUANTITY	LIST PRICE
	81847-001	101/331 Knob/Lever & 9771/8771 Handlesets	Service Kit Required	N/A	Each	\$15.00
	820082-003	6-Way Adjustable Plain Latch Service Kit		Satin Nickel	Each	\$10.00
	820082-005	6-Way Adjustable Plain Latch Service Kit		Satin Chrome	Each	\$10.00
	820082-007	6-Way Adjustable Plain Latch Service Kit		Matte Black	Each	\$10.00

6-WAY ADJUSTABLE PLAIN LATCH

	PART NUMBER	COMPATIBILITY		FINISH	QUANTITY	LIST PRICE
	83715-001	101/331 Knob/Lever & 9771/8771 Handlesets		Satin Nickel	Each	\$24.00
	83715-002	101/331 Knob/Lever & 9771/8771 Handlesets		Satin Chrome	Each	\$24.00
	83715-003	101/331 Knob/Lever & 9771/8771 Handlesets		Matte Black	Each	\$24.00
	83719-001	101 Knob/Lever	20 Minute Fire Rated	Satin Nickel	Each	\$27.00
	83719-002	101 Knob/Lever	20 Minute Fire Rated	Satin Chrome	Each	\$27.00
	83719-003	101 Knob/Lever	20 Minute Fire Rated	Matte Black	Each	\$27.00
	820004-001	101/331 Knob/Lever & 9771/8771 Handlesets	Visual Pack	Brass	Each	\$26.00
	820004-002	101/331 Knob/Lever & 9771/8771 Handlesets	Visual Pack	Satin Chrome	Each	\$26.00
	820004-003	101/331 Knob/Lever & 9771/8771 Handlesets	Visual Pack	Satin Nickel	Each	\$26.00
	820004-004	101/331 Knob/Lever & 9771/8771 Handlesets	Visual Pack	Matte Black	Each	\$26.00
	820004-005	101/331 Knob/Lever & 9771/8771 Handlesets	Visual Pack	Gunmetal	Each	\$26.00

FIXED FACEPLATE PLAIN LATCH

	PART NUMBER	COMPATIBILITY		FINISH	QUANTITY	LIST PRICE
	820091-003	101 Knob/Lever - 2-3/4" Square Faced Plain Latch	3 Hour Fire Rated	Satin Nickel	Each	\$30.00
	820091-005	101 Knob/Lever - 2-3/4" Square Faced Plain Latch	3 Hour Fire Rated	Satin Chrome	Each	\$30.00
	820091-006	101 Knob/Lever - 2-3/4" Square Faced Plain Latch	3 Hour Fire Rated	Matte Black	Each	\$30.00
	820090-003	101 Knob/Lever - 2-3/8" Square Faced Plain Latch	3 Hour Fire Rated	Satin Nickel	Each	\$30.00
	820090-005	101 Knob/Lever - 2-3/8" Square Faced Plain Latch	3 Hour Fire Rated	Satin Chrome	Each	\$30.00
	820090-006	101 Knob/Lever - 2-3/8" Square Faced Plain Latch	3 Hour Fire Rated	Matte Black	Each	\$30.00

Intro

Electronics

Box Pack

Visual Pack



Padlocks

Parts



SAFELOCK PLAIN LATCH

	PART NUMBER	COMPATIBILITY		FINISH	QUANTITY	LIST PRICE
	810000-435	6-Way Adjustable Plain Latch - 1000/3000 Knob/Lever & 1100 Handlesets		Satin Chrome	Each	\$20.00
	810000-436	6-Way Adjustable Plain Latch - 1000/3000 Knob/Lever & 1100 Handlesets		Satin Nickel	Each	\$20.00
	810000-437	6-Way Adjustable Plain Latch - 1000/3000 Knob/Lever & 1100 Handlesets		Matte Black	Each	\$20.00
	810000-448	4-Way Adjustable Plain Latch - 1000 Knob/Lever	20 Minute Fire Rated	Satin Nickel	Each	\$23.00
	810000-449	4-Way Adjustable Plain Latch - 1000 Knob/Lever	20 Minute Fire Rated	Satin Chrome	Each	\$23.00
	810000-450	4-Way Adjustable Plain Latch - 1000 Knob/Lever	20 Minute Fire Rated	Matte Black	Each	\$23.00



SAFELOCK FIXED FACEPLATE LATCH

	PART NUMBER	COMPATIBILITY		FINISH	QUANTITY	LIST PRICE
	810000-454	Square Corner Plain Latch - 1000 Knob/Lever	3 Hour Fire Rated	Satin Nickel	Each	\$26.00
	810000-455	Square Corner Plain Latch - 1000 Knob/Lever	3 Hour Fire Rated	Polished Chrome	Each	\$26.00
	810000-456	Square Corner Plain Latch - 1000 Knob/Lever	3 Hour Fire Rated	Matte Black	Each	\$26.00
	810000-451	Radius Corner Plain Latch - 1000 Knob/Lever	3 Hour Fire Rated	Satin Nickel	Each	\$26.00
	810000-452	Radius Corner Plain Latch - 1000 Knob/Lever	3 Hour Fire Rated	Polished Chrome	Each	\$26.00
	810000-453	Radius Corner Plain Latch - 1000 Knob/Lever	3 Hour Fire Rated	Matte Black	Each	\$26.00



6-WAY ADJUSTABLE DEAD LATCH & KIT

	PART NUMBER	COMPATIBILITY		FINISH	QUANTITY	LIST PRICE
	81846-001	531/535/581 Knob/Lever	Service Kit Required	N/A	Each	\$17.00
	820081-001	6-Way Adjustable Dead Latch Service Kit		Brass	Each	\$10.00
	820081-003	6-Way Adjustable Dead Latch Service Kit		Satin Nickel	Each	\$10.00
	820081-005	6-Way Adjustable Dead Latch Service Kit		Satin Chrome	Each	\$10.00
	820081-007	6-Way Adjustable Dead Latch Service Kit		Matte Black	Each	\$10.00

6-WAY ADJUSTABLE DEAD LATCH

	PART NUMBER	COMPATIBILITY		FINISH	QUANTITY	LIST PRICE
	83718-001	531/535/581 Knob/Lever, SmartCode Lever, SmartCode Commercial Lever	20 Minute Fire Rated	Satin Nickel	Each	\$29.00
	83718-002	531/535/581 Knob/Lever, SmartCode Lever, SmartCode Commercial Lever	20 Minute Fire Rated	Satin Chrome	Each	\$29.00
	83718-003	531/535/581 Knob/Lever, SmartCode Lever, SmartCode Commercial Lever	20 Minute Fire Rated	Matte Black	Each	\$29.00
	820003-001	531/535/581 Knob/Lever, SmartCode Lever, SmartCode Commercial Lever	Visual Pack	Brass	Each	\$28.00
	820003-002	531/535/581 Knob/Lever, SmartCode Lever, SmartCode Commercial Lever	Visual Pack	Satin Chrome	Each	\$28.00
	820003-003	531/535/581 Knob/Lever, SmartCode Lever, SmartCode Commercial Lever	Visual Pack	Satin Nickel	Each	\$28.00
	820003-004	531/535/581 Knob/Lever, SmartCode Lever, SmartCode Commercial Lever	Visual Pack	Matte Black	Each	\$28.00

FIXED FACEPLATE DEAD LATCH

	PART NUMBER	COMPATIBILITY		FINISH	QUANTITY	LIST PRICE
	83717-001	531/535/581 Knob/Lever - 2-3/4" Square Faced Dead Latch	3 Hour Fire Rated	Satin Nickel	Each	\$32.00
	83717-002	531/535/581 Knob/Lever - 2-3/4" Square Faced Dead Latch	3 Hour Fire Rated	Satin Chrome	Each	\$32.00
	83717-003	531/535/581 Knob/Lever - 2-3/4" Square Faced Dead Latch	3 Hour Fire Rated	Matte Black	Each	\$32.00
	83716-001	531/535/581 Knob/Lever - 2-3/8" Square Faced Dead Latch	3 Hour Fire Rated	Satin Nickel	Each	\$32.00
	83716-002	531/535/581 Knob/Lever - 2-3/8" Square Faced Dead Latch	3 Hour Fire Rated	Satin Chrome	Each	\$32.00
	83716-003	531/535/581 Knob/Lever - 2-3/8" Square Faced Dead Latch	3 Hour Fire Rated	Matte Black	Each	\$32.00

SAFELOCK DEAD LATCH

	PART NUMBER	COMPATIBILITY		FINISH	QUANTITY	LIST PRICE
	810000-439	5000 Knob/Lever		Satin Nickel	Each	\$22.00
	810000-438	5000 Knob/Lever		Satin Chrome	Each	\$22.00
	810000-440	5000 Knob/Lever		Matte Black	Each	\$22.00

Intro

Electronics

Box Pack

Visual Pack

Padlocks

Parts





5" DEAD LATCH

	PART NUMBER	COMPATIBILITY	FINISH	QUANTITY	LIST PRICE
	820061-001	531/535/581 Knob/Lever	Brass	Each	\$26.00
	820061-003	531/535/581 Knob/Lever	Satin Chrome	Each	\$26.00
	820061-004	531/535/581 Knob/Lever	Matte Black	Each	\$26.00

GATELATCH

	PART NUMBER	COMPATIBILITY	FINISH	QUANTITY	LIST PRICE
	820234-001	9471 Deadbolt - 2-3/4" Square Faced Gate Latch	Brass	Each	\$47.00
	820234-004	9471 Deadbolt - 2-3/4" Square Faced Gate Latch	Satin Chrome	Each	\$47.00
	820233-004	9471 Deadbolt - 2-3/8" Square Faced Gate Latch	Satin Chrome	Each	\$47.00

DEADBOLT STRIKES

	PART NUMBER	DESCRIPTION	COMPATIBILITY	FINISH	QUANTITY	LIST PRICE
	820049-005	Deadbolt, 4 Hole Strike, Square Corner	Standard deadbolt strike on all deadbolts and handlesets - Square Corner	Satin Nickel	Each	\$12.00
	820049-003	Deadbolt, 4 Hole Strike, Square Corner	Standard deadbolt strike on all deadbolts and handlesets - Square Corner	Satin Chrome	Each	\$12.00
	820049-007	Deadbolt, 4 Hole Strike, Square Corner	Standard deadbolt strike on all deadbolts and handlesets - Square Corner	Matte Black	Each	\$12.00
	820049-008	Deadbolt, 4 Hole Strike, Square Corner	Standard deadbolt strike on all deadbolts and handlesets - Square Corner	Satin Brass	Each	\$12.00
	820050-005	Deadbolt, 4 Hole Strike, Radius Corner	Standard deadbolt strike on all deadbolts and handlesets - Radius Corner	Satin Nickel	Each	\$12.00
	820050-003	Deadbolt, 4 Hole Strike, Radius Corner	Standard deadbolt strike on all deadbolts and handlesets - Radius Corner	Satin Chrome	Each	\$12.00
	820050-004	Deadbolt, 4 Hole Strike, Radius Corner	Standard deadbolt strike on all deadbolts and handlesets - Radius Corner	Satin Chrome	Each	\$12.00
	820050-007	Deadbolt, 4 Hole Strike, Radius Corner	Standard deadbolt strike on all deadbolts and handlesets - Radius Corner	Satin Brass	Each	\$12.00
	84248-003	Deadbolt, 4 Hole Strike, Square Corner with Screw Pack	SmartCode Keypad/Touchpad, Aura/Halo/Halo Touch with Screw Pack - Square Corner	Satin Nickel	Each	\$12.00
	84248-002	Deadbolt, 4 Hole Strike, Square Corner with Screw Pack	SmartCode Keypad/Touchpad, Aura/Halo/Halo Touch with Screw Pack - Square Corner	Satin Chrome	Each	\$12.00
	84248-001	Deadbolt, 4 Hole Strike, Square Corner with Screw Pack	SmartCode Keypad/Touchpad, Aura/Halo/Halo Touch with Screw Pack - Square Corner	Matte Black	Each	\$12.00
	84358-001	Deadbolt, 2 Hole Strike	Elements Keypad/Powerbolt3 - Square Corner	Brass	Each	\$12.00
	84358-004	Deadbolt, 2 Hole Strike	Elements Keypad/Powerbolt3 - Square Corner	Bronze	Each	\$12.00
	84358-003	Deadbolt, 2 Hole Strike	Elements Keypad/Powerbolt3 - Square Corner	Satin Nickel	Each	\$12.00
	84358-002	Deadbolt, 2 Hole Strike	Elements Keypad/Powerbolt3 - Square Corner	Satin Chrome	Each	\$12.00
	84358-005	Deadbolt, 2 Hole Strike	Elements Keypad/Powerbolt3 - Square Corner	Matte Black	Each	\$12.00

DEADBOLT STRIKES

	PART NUMBER	DESCRIPTION	FINISH	QUANTITY	LIST PRICE
	85278-020	Deadbolt, 1-1/8" x 2- 3/4", Square Corner	Satin Nickel	Each	\$12.00
	85278-021	Deadbolt, 1-1/8" x 2- 3/4", Square Corner	Satin Chrome	Each	\$12.00
	85278-019	Deadbolt, 1-1/8" x 2- 3/4", Square Corner	Matte Black	Each	\$12.00

Intro

Electronics

Box Pack

Visual Pack

Padlocks

Parts

DEADBOLT STRIKES

	PART NUMBER	DESCRIPTION	FINISH	QUANTITY	LIST PRICE
	85279-009	Deadbolt, 1-1/8" x 2- 3/4", Radius Corner	Satin Nickel	Each	\$12.00
	85279-002	Deadbolt, 1-1/8" x 2- 3/4", Radius Corner	Satin Chrome	Each	\$12.00
	85279-015	Deadbolt, 1-1/8" x 2- 3/4", Radius Corner	Matte Black	Each	\$12.00
	85279-017	Deadbolt, 1-1/8" x 2- 3/4", Radius Corner	Gunmetal	Each	\$12.00
	84638-008	Deadbolt, Full Lip Square Corner	Satin Nickel	Each	\$12.00
	84638-002	Deadbolt, Full Lip Square Corner	Satin Chrome	Each	\$12.00
	84638-010	Deadbolt, Full Lip Square Corner	Matte Black	Each	\$12.00
	84638-013	Deadbolt, Full Lip Square Corner	Satin Brass	Each	\$12.00
	85303-018	Deadbolt, Full Lip Radius Corner	Satin Nickel	Each	\$12.00
	85303-016	Deadbolt, Full Lip Radius Corner	Satin Chrome	Each	\$12.00
	85303-017	Deadbolt, Full Lip Radius Corner	Matte Black	Each	\$12.00
	85303-019	Deadbolt, Full Lip Radius Corner	Satin Brass	Each	\$12.00
	85303-020	Deadbolt, Full Lip Radius Corner	Gunmetal	Each	\$12.00
	85072-019	Deadbolt 1"x 2-1/4", Square Corner	Satin Nickel	Each	\$12.00
	85072-004	Deadbolt 1"x 2-1/4", Square Corner	Satin Chrome	Each	\$12.00
	85072-018	Deadbolt 1"x 2-1/4", Square Corner	Matte Black	Each	\$12.00
	85072-021	Deadbolt 1"x 2-1/4", Square Corner	Satin Brass	Each	\$12.00
	85072-022	Deadbolt 1"x 2-1/4", Square Corner	Gunmetal	Each	\$12.00
	85063-014	Deadbolt 1"x 2-1/4", Radius Corner	Satin Nickel	Each	\$12.00
	85063-013	Deadbolt 1"x 2-1/4", Radius Corner	Satin Chrome	Each	\$12.00
	85063-008	Deadbolt 1"x 2-1/4", Radius Corner	Matte Black	Each	\$12.00
	85063-015	Deadbolt 1"x 2-1/4", Radius Corner	Satin Brass	Each	\$12.00
	85063-016	Deadbolt 1"x 2-1/4", Radius Corner	Gunmetal	Each	\$12.00
	84632-005	T Strike	Satin Nickel	Each	\$12.00
	84632-002	T Strike	Satin Chrome	Each	\$12.00
	84632-007	T Strike	Matte Black	Each	\$12.00

Intro

Electronics





Box Pack

Visual Pack

Padlocks

Parts

PLAIN LATCH STRIKES

	PART NUMBER	DESCRIPTION	COMPATIBILITY	FINISH	QUANTITY	LIST PRICE
	83437-048	Full Lip Square Corner Standard on Non-UL Locksets	Standard strike on all levers and knobs - Square Corner	Brass	Each	\$12.00
	83437-045	Full Lip Square Corner Standard on Non-UL Locksets	Standard strike on all levers and knobs - Square Corner	Satin Nickel	Each	\$12.00
	83437-036	Full Lip Square Corner Standard on Non-UL Locksets	Standard strike on all levers and knobs - Square Corner	Satin Chrome	Each	\$12.00
	83437-040	Full Lip Square Corner Standard on Non-UL Locksets	Standard strike on all levers and knobs - Square Corner	Matte Black	Each	\$12.00
	83437-048	Full Lip Square Corner Standard on Non-UL Locksets	Standard strike on all levers and knobs - Square Corner	Satin Brass	Each	\$12.00
	83437-050	Full Lip Square Corner Standard on Non-UL Locksets	Standard strike on all levers and knobs - Square Corner	Gunmetal	Each	\$12.00
	83796-021	Full Lip Radius Corner Standard on Non-UL Locksets	Standard strike on all levers and knobs - Radius Corner	Brass	Each	\$12.00
	83796-022	Full Lip Radius Corner Standard on Non-UL Locksets	Standard strike on all levers and knobs - Radius Corner	Satin Nickel	Each	\$12.00
	83796-011	Full Lip Radius Corner Standard on Non-UL Locksets	Standard strike on all levers and knobs - Radius Corner	Satin Chrome	Each	\$12.00
	83796-019	Full Lip Radius Corner Standard on Non-UL Locksets	Standard strike on all levers and knobs - Radius Corner	Matte Black	Each	\$12.00
	83796-024	Full Lip Radius Corner Standard on Non-UL Locksets	Standard strike on all levers and knobs - Radius Corner	Satin Brass	Each	\$12.00
	83030-005	Full Lip Square Corner Strike, UL Option	UL Standard strike on all levers and knobs - Square Corner	Satin Nickel	Each	\$12.00
	83030-003	Full Lip Square Corner Strike, UL Option	UL Standard strike on all levers and knobs - Square Corner	Satin Chrome	Each	\$12.00
	83030-007	Full Lip Square Corner Strike, UL Option	UL Standard strike on all levers and knobs - Square Corner	Matte Black	Each	\$12.00
	83031-005	Full Lip Radius Corner Strike, UL Option	UL Standard strike on all levers and knobs - Radius Corner	Satin Nickel	Each	\$12.00
	83031-003	Full Lip Radius Corner Strike, UL Option	UL Standard strike on all levers and knobs - Radius Corner	Satin Chrome	Each	\$12.00
	83031-007	Full Lip Radius Corner Strike, UL Option	UL Standard strike on all levers and knobs - Radius Corner	Matte Black	Each	\$12.00

Intro

Electronics





Box Pack

Visual Pack

Padlocks

Parts

PLAIN LATCH STRIKES

	PART NUMBER	DESCRIPTION	FINISH	QUANTITY	LIST PRICE
	83537-003	Extended Lip Strike Square Corner	Satin Nickel	Each	\$12.00
	83537-002	Extended Lip Strike Square Corner	Polished Chrome	Each	\$12.00
	83537-004	Extended Lip Strike Square Corner	Matte Black	Each	\$12.00
	83846-015	ASA Strike	Satin Nickel	Each	\$12.00
	83846-004	ASA Strike	Satin Chrome	Each	\$12.00
	83846-017	ASA Strike	Matte Black	Each	\$12.00
	83028-024	T Strike	Brass	Each	\$12.00
	83028-019	T Strike	Satin Nickel	Each	\$12.00
	83028-010	T Strike	Satin Chrome	Each	\$12.00
	83028-023	T Strike	Matte Black	Each	\$12.00
	83288-001	Box for 83028 T Strike	N/A	Each	\$12.00
	81231-001	Box for Full Lip Strike	N/A	Each	\$12.00

P&T REKEYING SUPPLIES

	PART NUMBER	DESCRIPTION	QUANTITY	LIST PRICE
	81467-003	Cylinder Removal Tool	Each	\$7.00
	80049-001	Key Stop Gauge	Each	\$23.00
	80152-001	Plug Follower Tool	Each	\$26.00
	83100-001	KW1 P&T #1 BOTTOM PIN .172"	Bag/100	\$13.00
	83101-001	KW1 P&T #2 BOTTOM PIN .195"	Bag/100	\$13.00
	83103-001	KW1 P&T #3 BOTTOM PIN .218"	Bag/100	\$13.00
	83105-001	KW1 P&T #4 BOTTOM PIN .241"	Bag/100	\$13.00
	83106-001	KW1 P&T #5 BOTTOM PIN .264"	Bag/100	\$13.00
	83107-001	KW1 P&T #6 BOTTOM PIN .287"	Bag/100	\$13.00
	83108-001	KW1 P&T #1 MASTER PIN .023"	Bag/100	\$13.00
	83110-001	KW1 P&T #2 MASTER PIN .046"	Bag/100	\$13.00
	83112-001	KW1 P&T #3 MASTER PIN .069"	Bag/100	\$13.00
	83113-001	KW1 P&T #4 MASTER PIN .092"	Bag/100	\$13.00
	83114-001	KW1 P&T #5 MASTER PIN .115"	Bag/100	\$13.00
	83125-001	KW1 P&T #6 MASTER PIN .138"	Bag/100	\$13.00
	81858-001	KW1 P&T REGULAR TOP PIN .180"	Bag/100	\$13.00
	83117-001	KW1 P&T PK TOP PIN .160"	Bag/100	\$13.00
	82208-001	KW1 P&T PK Balls	Bag/100	\$13.00
	81777-001	KW1 P&T Tumbler Spring	Bag/100	\$13.00
	84345-001	Knob Plug Retainer Clip	Bag/1	\$13.00
	84215-001	Deadlock Plug Retainer Clip	Bag/1	\$13.00
	87809-001	Locking Bar	Bag/1	\$13.00

Intro

Electronics

Box Pack

Visual Pack

Padlocks

Parts

P&T REKEYING SUPPLIES

	PART NUMBER	DESCRIPTION	QUANTITY	LIST PRICE
	85757-001	Spring Cover	Bag/50	\$7.00
	87632-001	Spring	Bag/100	\$13.00
	800000-041	WR5 Cylinder Cap Tool	Each	\$13.00
	800000-126	WR5 P&T UNIV TOP PINS	Bag/100	\$13.00
	800000-136	WR5 P&T #0 BOTTOM PINS	Bag/100	\$13.00
	800000-127	WR5 P&T #1 BOTTOM PINS	Bag/100	\$13.00
	800000-128	WR5 P&T #2 BOTTOM PINS	Bag/100	\$13.00
	800000-129	WR5 P&T #3 BOTTOM PINS	Bag/100	\$13.00
	800000-130	WR5 P&T #4 BOTTOM PINS	Bag/100	\$13.00
	800000-131	WR5 P&T #5 BOTTOM PINS	Bag/100	\$13.00
	800000-132	WR5 P&T #6 BOTTOM PINS	Bag/100	\$13.00
	800000-133	WR5 P&T #7 BOTTOM PINS	Bag/100	\$13.00
	800000-134	WR5 P&T #8 BOTTOM PINS	Bag/100	\$13.00
	800000-135	WR5 P&T #9 BOTTOM PINS	Bag/100	\$13.00
	800000-167	WR5 P&T #2 MASTER WAFER	Bag/100	\$13.00
	800000-168	WR5 P&T #3 MASTER WAFER	Bag/100	\$13.00
	800000-169	WR5 P&T #4 MASTER WAFER	Bag/100	\$13.00
	800000-172	WR5 P&T #7 MASTER WAFER	Bag/100	\$13.00
	800000-173	WR5 P&T #8 MASTER WAFER	Bag/100	\$13.00

DEADBOLT SCREW PACKS

	PART NUMBER	COMPATIBILITY	FINISH	QUANTITY	LIST PRICE
	83015-002	GD 1471 Deadbolt Screw Pack	Satin Nickel	Each	\$11.00
	83015-001	GD 1471 Deadbolt Screw Pack	Satin Chrome	Each	\$11.00
	83015-003	GD 1471 Deadbolt Screw Pack	Matte Black	Each	\$11.00
	83015-005	GD 1471 Deadbolt Screw Pack	Satin Brass	Each	\$11.00
	83015-006	GD 1471 Deadbolt Screw Pack	Gunmetal	Each	\$11.00
	81247-006	GCD 9471 Deadbolt Screw Pack	Satin Nickel	Each	\$11.00
	81247-001	GCD 9471 Deadbolt Screw Pack	Satin Chrome	Each	\$11.00
	81247-008	GCD 9471 Deadbolt Screw Pack	Matte Black	Each	\$11.00
	820083-001	GD 9471 Deadbolt Screw Pack	Brass	Each	\$11.00
	820083-003	GD 9471 Deadbolt Screw Pack	Satin Nickel	Each	\$11.00
	820083-002	GD 9471 Deadbolt Screw Pack	Satin Chrome	Each	\$11.00
	820083-004	GD 9471 Deadbolt Screw Pack	Matte Black	Each	\$11.00
	820285-002	SSD 9471 Deadbolt Screw Pack	Satin Nickel	Each	\$11.00
	820285-001	SSD 9471 Deadbolt Screw Pack	Satin Chrome	Each	\$11.00
	820285-003	SSD 9471 Deadbolt Screw Pack	Matte Black	Each	\$11.00
	86171-003	GDC 9471 Deadbolt Screw Pack	Satin Nickel	Each	\$11.00
	86171-002	GDC 9471 Deadbolt Screw Pack	Satin Chrome	Each	\$11.00
	86171-004	GDC 9471 Deadbolt Screw Pack	Matte Black	Each	\$11.00
	83393-003	Key Control Deadbolt Security Mounting Screws	Satin Nickel	Each	\$11.00
	83393-002	Key Control Deadbolt Security Mounting Screws	Polished Chrome	Each	\$11.00
	83393-004	Key Control Deadbolt Security Mounting Screws	Matte Black	Each	\$11.00
	83390-002	Key Control Deadbolt Mounting Screws	Satin Nickel	Each	\$11.00
	83390-003	Key Control Deadbolt Mounting Screws	Satin Chrome	Each	\$11.00

Intro

Electronics







Box Pack

Visual Pack

Padlocks

Parts

HANDLESET SCREW PACKS

	PART NUMBER	COMPATIBILITY	FINISH	QUANTITY	LIST PRICE
	83725-001	Handleset Deadbolt Mounting Screws	Satin Nickel	Each	\$11.00
	83725-002	Handleset Deadbolt Mounting Screws	Polished Chrome	Each	\$11.00
	83725-003	Handleset Deadbolt Mounting Screws	Matte Black	Each	\$11.00
	83721-002	Elements Handleset Mounting Screws	Satin Nickel	Each	\$11.00
	83721-003	Elements Handleset Mounting Screws	Satin Chrome	Each	\$11.00
	83721-001	Elements Handleset Mounting Screws	Matte Black	Each	\$11.00
	82213-002	Handleset Bottom Screw & Washer -GA/GLA 9771/9471	N/A	Each	\$11.00
	83004-001	Handleset Bottom Screw & Washer - GA/GLA 8771/8471	Silver	Each	\$11.00
	81696-002	Contemporary Handleset Interior Screw Cap Cover	Satin Nickel	Each	\$11.00
	81696-003	Contemporary Handleset Interior Screw Cap Cover	Satin Chrome	Each	\$11.00
	81696-005	Contemporary Handleset Interior Screw Cap Cover	Matte Black	Each	\$11.00
	81696-006	Contemporary Handleset Interior Screw Cap Cover	Satin Brass	Each	\$11.00
	81696-009	Contemporary Handleset Interior Screw Cap Cover	Gunmetal	Each	\$11.00
	82215-003	Decorative Handleset Interior Screw Cap Cover	Satin Nickel	Each	\$11.00
	82215-005	Decorative Handleset Interior Screw Cap Cover	Polished Chrome	Each	\$11.00
	82215-006	Decorative Handleset Interior Screw Cap Cover	Satin Chrome	Each	\$11.00
	82215-010	Decorative Handleset Interior Screw Cap Cover	Matte Black	Each	\$11.00
	88322-009	Elements Handleset Bottom Sex Nut & Wood Screw	Satin Nickel	Each	\$11.00

Intro

Electronics

Box Pack

Visual Pack



Padlocks

Parts

KNOB & LEVER SCREW PACKS

	PART NUMBER	COMPATIBILITY	FINISH	QUANTITY	LIST PRICE
	85201-003	Passage, Privacy, Entry & Interior Pack Chassis Screws for Knob/Levers - Weiser Portfolio	Satin Brass	Each	\$11.00
	85201-001	Passage, Privacy, Entry & Interior Pack Chassis Screws for Knob/Levers - Weiser Portfolio	Satin Nickel	Each	\$11.00
	85201-002	Passage, Privacy, Entry & Interior Pack Chassis Screws for Knob/Levers - Weiser Portfolio	Matte Black	Each	\$11.00
	89930-003	Passage, Privacy, Entry & Interior Pack Chassis Screws for Contemporary Levers - Weiser Portfolio	Satin Nickel	Each	\$11.00
	89930-001	Passage, Privacy, Entry & Interior Pack Chassis Screws for Contemporary Levers - Weiser Portfolio	Satin Chrome	Each	\$11.00
	89930-002	Passage, Privacy, Entry & Interior Pack Chassis Screws for Contemporary Levers - Weiser Portfolio	Matte Black	Each	\$11.00
	89930-004	Passage, Privacy, Entry & Interior Pack Chassis Screws for Contemporary Levers - Weiser Portfolio	Satin Brass	Each	\$11.00
	89930-005	Passage, Privacy, Entry & Interior Pack Chassis Screws for Contemporary Levers - Weiser Portfolio	Gunmetal	Each	\$11.00
	86151-008	Elements Inner Trim Knob/Lever Screws Pack	Gold	Each	\$11.00
	86151-007	Elements Inner Trim Knob/Lever Screws Pack	Silver	Each	\$11.00
	86151-006	Elements Inner Trim Knob/Lever Screws Pack	Black	Each	\$11.00
	81711-001	Knob/Lever Strike/Latch Screw Pack	Brass	Each	\$11.00
	81711-002	Knob/Lever Strike/Latch Screw Pack	Satin Nickel	Each	\$11.00
	81711-004	Knob/Lever Strike/Latch Screw Pack	Matte Black	Each	\$11.00

INACTIVE/DUMMY SCREW PACKS

	PART NUMBER	COMPATIBILITY	FINISH	QUANTITY	LIST PRICE
	83751-002	Dummy Surface Mounting Screws for Levers/Knobs	Satin Nickel	Each	\$11.00
	83751-001	Dummy Surface Mounting Screws for Levers/Knobs	Matte Black	Each	\$11.00
	89932-003	Dummy Surface Mounting Screws for Contemporary Levers - Weiser Portfolio	Satin Nickel	Each	\$11.00
	89932-001	Dummy Surface Mounting Screws for Contemporary Levers - Weiser Portfolio	Satin Chrome	Each	\$11.00
	89932-002	Dummy Surface Mounting Screws for Contemporary Levers - Weiser Portfolio	Matte Black	Each	\$11.00
	89932-004	Dummy Surface Mounting Screws for Contemporary Levers - Weiser Portfolio	Satin Brass	Each	\$11.00
	89932-005	Dummy Surface Mounting Screws for Contemporary Levers - Weiser Portfolio	Gunmetal	Each	\$11.00
	83726-002	Dummy Thru-Bolt Mounting Screws	Satin Nickel	Each	\$11.00
	83726-001	Dummy Thru-Bolt Mounting Screws	Matte Black	Each	\$11.00

Intro

Electronics

Box Pack

Visual Pack





Padlocks

Parts

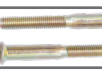

SET SCREW PACKS

	PART NUMBER	COMPATIBILITY	QUANTITY	LIST PRICE
	83257-001	Exterior Entry SMT Set Screw	Each	\$11.00
	83255-001	Interior Entry Pin & Tumbler Entry Set Screw	Each	\$11.00
	83256-001	Exterior Entry Pin & Tumbler Entry Set Screw	Each	\$11.00
	83254-001	Passage/Privacy/Interior Entry Set Screw	Each	\$11.00

ELECTRONIC SCREW PACKS

	PART NUMBER	COMPATIBILITY	FINISH	QUANTITY	LIST PRICE
	84252-001	SmartCode Keypad/Touchpad - Interior Chassis Mounting Screws	N/A	Each	\$11.00
	84250-001	SmartCode Keypad/Touchpad - Mounting Screws	N/A	Each	\$11.00
	84354-001	Powerbolt 3 & Elements by Weiser Electronic Deadbolt - Mounting Screws	N/A	Each	\$11.00
	84243-001	SmartCode Keypad/Touchpad - Thick Door Door Kit, Cylinder and 2 Keys	Silver	Each	\$35.00
	84243-002	SmartCode Keypad/Touchpad - Thick Door Door Kit, Cylinder and 2 Keys	Black	Each	\$35.00
	84355-001	Powerbolt 3 & Elements by Weiser Electronic Deadbolt - Thick Door Door Kit	N/A	Each	\$11.00
	84376-001	Halo Select- Think Door Screws	N/A	Each	\$13.00

SAFE LOCK SCREW PACKS

	PART NUMBER	COMPATIBILITY	FINISH	QUANTITY	LIST PRICE
	810000-411	9100 Deadbolts	Satin Nickel	Each	\$11.00
	810000-412	9100 Deadbolts	Matte Black	Each	\$11.00
	810000-457	1000/3000/5000 Knob/Lever	Satin Nickel	Each	\$11.00
	810000-458	1000/3000/5000 Knob/Lever	Matte Black	Each	\$11.00
	810000-460	7000 Knob/Lever	Satin Nickel	Each	\$11.00
	810000-459	7000 Knob/Lever	Matte Black	Each	\$11.00

THIN/THICK DOOR SCREW PACKS

	PART NUMBER	COMPATIBILITY	FINISH	QUANTITY	LIST PRICE
	83017-002	GD 1471 Thin Door Screw Pack 1-3/8"	Satin Nickel	Each	\$11.00
	83017-001	GD 1471 Thin Door Screw Pack 1-3/8"	Satin Chrome	Each	\$11.00
	83017-003	GD 1471 Thin Door Screw Pack 1-3/8"	Matte Black	Each	\$11.00
	83022-002	GD 1471 Thick Door Screw Pack	Satin Nickel	Each	\$13.00
	83022-001	GD 1471 Thick Door Screw Pack	Satin Chrome	Each	\$13.00
	83022-003	GD 1471 Thick Door Screw Pack	Matte Black	Each	\$13.00
	83022-005	GD 1471 Thick Door Screw Pack	Satin Brass	Each	\$13.00
	81691-006	GCD9471/GD9471 Thick Door Screw Pack	Brass	Each	\$13.00
	81691-007	GCD9471/GD9471 Thick Door Screw Pack	Satin Nickel	Each	\$13.00
	81691-002	GCD9471/GD9471 Thick Door Screw Pack	Satin Chrome	Each	\$13.00
	81691-005	GCD9471/GD9471 Thick Door Screw Pack	Matte Black	Each	\$13.00
	820289-002	SSD9471 Thick Door Screw Pack	Satin Nickel	Each	\$13.00
	820289-001	SSD9471 Thick Door Screw Pack	Satin Chrome	Each	\$13.00
	820289-003	SSD9471 Thick Door Screw Pack	Matte Black	Each	\$13.00
	86129-001	GDC9471 Thick Door Screw Pack	Brass	Each	\$13.00
	86129-007	GDC9471 Thick Door Screw Pack	Satin Nickel	Each	\$13.00
	86129-006	GDC9471 Thick Door Screw Pack	Satin Chrome	Each	\$13.00
	86129-008	GDC9471 Thick Door Screw Pack	Matte Black	Each	\$13.00
	81838-004	Handleset Adapter Thick Door Pack	Satin Nickel	Each	\$13.00
	81838-002	Handleset Adapter Thick Door Pack	Polished Chrome	Each	\$13.00
	81838-003	Handleset Adapter Thick Door Pack	Matte Black	Each	\$13.00
	83397-002	Key Control Deadbolt Thin Door Pack	N/A	Each	\$13.00

Intro

Electronics







Box Pack

Visual Pack

Padlocks

Parts

THIN/THICK DOOR SCREW PACKS

	PART NUMBER	COMPATIBILITY	FINISH	QUANTITY	LIST PRICE
	88376-004	Thick Door Handleset Screw & Washer for Elements Handlesets	Satin Nickel	Each	\$13.00
	88376-005	Thick Door Handleset Screw & Washer for Elements Handlesets	Satin Chrome	Each	\$13.00
	88376-003	Thick Door Handleset Screw & Washer for Elements Handlesets	Matte Black	Each	\$13.00
	81861-001	Thick Door Handleset Screw & Washer for Contemporary Handlesets	N/A	Each	\$13.00
	83724-001	Thick Door Handleset Screw & Washer Augusta/Hawthorne/Tavaris	N/A	Each	\$13.00
	83669-001	Handleset Mechanism with Thick Door Spindle	N/A	Each	\$26.00
	85202-001	Thick Door Screw Pack for Passage, Privacy, Entry & Interior Pack Chassis Screws for Knob/Levers - Weiser Portfolio	Satin Nickel	Each	\$13.00
	85202-002	Thick Door Screw Pack for Passage, Privacy, Entry & Interior Pack Chassis Screws for Knob/Levers - Weiser Portfolio	Matte Black	Each	\$13.00
	89933-003	Thick Door Screw Pack for Contemporary Levers - Weiser Portfolio	Satin Nickel	Each	\$13.00
	89933-001	Thick Door Screw Pack for Contemporary Levers - Weiser Portfolio	Satin Chrome	Each	\$13.00
	89933-002	Thick Door Screw Pack for Contemporary Levers - Weiser Portfolio	Matte Black	Each	\$13.00
	89933-004	Thick Door Screw Pack for Contemporary Levers - Weiser Portfolio	Satin Brass	Each	\$13.00
	83752-001	Passage Thick Door Exterior Chassis Kit - Weiser Portfolio	Satin Chrome	Each	\$26.00
	83752-002	Passage Thick Door Exterior Chassis Kit - Weiser Portfolio	Brass	Each	\$26.00
	83752-003	Passage Thick Door Exterior Chassis Kit - Weiser Portfolio	Satin Nickel	Each	\$26.00
	83752-004	Passage Thick Door Exterior Chassis Kit - Weiser Portfolio	Matte Black	Each	\$26.00
	81706-005	Thick Door Screw Pack for Elements Levers & all Knobs	Brass	Each	\$13.00
	81706-006	Thick Door Screw Pack for Elements Levers & all Knobs	Satin Nickel	Each	\$13.00
	81706-002	Thick Door Screw Pack for Elements Levers & all Knobs	Satin Chrome	Each	\$13.00
	81706-007	Thick Door Screw Pack for Elements Levers & all Knobs	Matte Black	Each	\$13.00

Intro

Electronics



Box Pack

Visual Pack



Padlocks

Parts

GA8771 HANDLESET THICK DOOR

PRAGUE, PRESCOTT, SAN CLEMENTE, VANCOUVER	PART NUMBER	COMPATIBILITY	FINISH	QUANTITY	LIST PRICE
Step 1. Choose your Deadbolt Screw Pack 	83022-002	GD 1471 Thick Door Screw Pack	Satin Nickel	Each	\$13.00
	83022-001	GD 1471 Thick Door Screw Pack	Satin Chrome	Each	\$13.00
	83022-003	GD 1471 Thick Door Screw Pack	Matte Black	Each	\$13.00
Step 2. Order Handleset Mechanism	83669-001	Handleset Mechanism with Thick Door Spindle	N/A	Each	\$26.00
Step 3. Order your Knob/Lever Screw Pack 	85202-001	Thick Door Screw Pack for Passage, Privacy, Entry & Interior Pack Chassis Screws for Knob/Levers - Weiser Portfolio	Satin Nickel	Each	\$13.00
	85202-002	Thick Door Screw Pack for Passage, Privacy, Entry & Interior Pack Chassis Screws for Knob/Levers - Weiser Portfolio	Matte Black	Each	\$13.00
	89933-003	Thick Door Screw Pack for Contemporary Levers - Weiser Portfolio	Satin Nickel	Each	\$13.00
	89933-001	Thick Door Screw Pack for Contemporary Levers - Weiser Portfolio	Satin Chrome	Each	\$13.00
	89933-002	Thick Door Screw Pack for Contemporary Levers - Weiser Portfolio	Matte Black	Each	\$13.00
Optional Step 4. Order your Bottom Screw Pack 	81861-001	Thick Door Handleset Screw & Washer for Contemporary Handlesets	Satin Nickel	Each	\$13.00

GA9771 HANDLESET THICK DOOR

AUGUSTA, HAWTHORNE, HERITAGE, TAVARIS	PART NUMBER	COMPATIBILITY	FINISH	QUANTITY	LIST PRICE
Step 1. Choose your Deadbolt Screw Pack 	81691-006	GCD9471/GD9471 Thick Door Screw Pack	Brass	Each	\$13.00
	81691-007	GCD9471/GD9471 Thick Door Screw Pack	Satin Nickel	Each	\$13.00
	81691-002	GCD9471/GD9471 Thick Door Screw Pack	Satin Chrome	Each	\$13.00
	81691-005	GCD9471/GD9471 Thick Door Screw Pack	Matte Black	Each	\$13.00
Step 2. Order Handleset Mechanism	83669-001	Handleset Mechanism with Thick Door Spindle	N/A	Each	\$26.00
Step 3. Order your Knob/Lever Screw Pack 	85202-001	Thick Door Screw Pack for Passage, Privacy, Entry & Interior Pack Chassis Screws for Knob/Levers - Weiser Portfolio	Satin Nickel	Each	\$13.00
	85202-002	Thick Door Screw Pack for Passage, Privacy, Entry & Interior Pack Chassis Screws for Knob/Levers - Weiser Portfolio	Matte Black	Each	\$13.00
	89933-003	Thick Door Screw Pack for Contemporary Levers - Weiser Portfolio	Satin Nickel	Each	\$13.00
	89933-001	Thick Door Screw Pack for Contemporary Levers - Weiser Portfolio	Satin Chrome	Each	\$13.00
	89933-002	Thick Door Screw Pack for Contemporary Levers - Weiser Portfolio	Matte Black	Each	\$13.00
Optional Step 4. Order your Bottom Screw Pack 	83724-001	Thick Door Handleset Screw & Washer Augusta/Hawthorne/Tavaris	N/A	Each	\$13.00

Intro

Electronics



Box Pack

Visual Pack

Padlocks

Parts

GAC9771 HANDLESET THICK DOOR

AMADOR, BRENTWOOD, HENLEY, KINGSWAY	PART NUMBER	COMPATIBILITY	FINISH	QUANTITY	LIST PRICE
Step 1. Choose your Deadbolt Screw Pack 	86129-001	GDC9471 Thick Door Screw Pack	Brass	Each	\$13.00
	86129-007	GDC9471 Thick Door Screw Pack	Satin Nickel	Each	\$13.00
	86129-006	GDC9471 Thick Door Screw Pack	Satin Chrome	Each	\$13.00
	86129-008	GDC9471 Thick Door Screw Pack	Matte Black	Each	\$13.00
Step 2. Order Handleset Mechanism	83669-001	Handleset Mechanism with Thick Door Spindle	N/A	Each	\$26.00
Step 3. Order your Knob/Lever Screw Pack 	81706-005	Thick Door Screw Pack for Elements Levers & all Knobs	Brass	Each	\$13.00
	81706-006	Thick Door Screw Pack for Elements Levers & all Knobs	Satin Nickel	Each	\$13.00
	81706-002	Thick Door Screw Pack for Elements Levers & all Knobs	Satin Chrome	Each	\$13.00
	81706-007	Thick Door Screw Pack for Elements Levers & all Knobs	Matte Black	Each	\$13.00
Optional Step 4. Order your Bottom Screw Pack 	88376-004	Thick Door Handleset Screw & Washer for Elements Handlesets	Satin Nickel	Each	\$13.00
	88376-005	Thick Door Handleset Screw & Washer for Elements Handlesets	Satin Chrome	Each	\$13.00
	88376-003	Thick Door Handleset Screw & Washer for Elements Handlesets	Matte Black	Each	\$13.00

ELECTRONIC PARTS

	PART NUMBER	COMPATIBILITY	FINISH	QUANTITY	LIST PRICE
	83509-001	Halo Select Door Sensor Magnet	N/A	Each	\$10.00
	84367-001	Halo Select Mounting Plate	N/A	Each	\$12.00
	84372-001	Halo Select Battery Pack	N/A	Each	\$25.00
	84370-001	Halo Select Battery Cover	N/A	Each	\$9.00
	84368-001	Halo Select Interior Chassis	N/A	Each	\$500.00
	84272-001	SmartCode Keypad/Touchpad Battery Cover		Each	\$9.00
	84353-001	Powerbolt 3 & Elements by Weiser Electronic Deadbolt Battery Cover		Each	\$9.00
	84249-001	SmartCode Keypad/Touchpad, Powerbolt 3 & Elements by Weiser Electronic Deadbolt Mounting Plate		Each	\$9.00

Intro

Electronics







Box Pack

Visual Pack

Padlocks

Parts

MISCELLANEOUS

	PART NUMBER	COMPATIBILITY	FINISH	QUANTITY	LIST PRICE
	800004-349	Legacy Weiser Handleset Mechanism		Each	\$62.00
	820309-001	Handleset Mechanism		Each	\$31.00
	820318-001	Deadbolt Frost Insert		Each	\$16.00
	81226-004	Inactive 9771 Deadbolt Cylinder Cover	Satin Nickel	Each	\$9.00
	81226-007	Inactive 9771 Deadbolt Cylinder Cover	Satin Chrome	Each	\$9.00
	81226-010	Inactive 9771 Deadbolt Cylinder Cover	Matte Black	Each	\$9.00
	81226-006	Inactive 9771 Deadbolt Cylinder Cover	Polished Chrome	Each	\$9.00
	800003-547	Weiser Finish Ring		Each	\$28.00
	83841-001	Halifax LED Lever & Cartridge	Matte Black	Each	\$54.00
	83841-001	Halifax LED Lever & Cartridge	Satin Nickel	Each	\$54.00

Intro

Electronics

Box Pack

Visual Pack

Padlocks

Parts

DEADBOLT BORE HOLE COMPATIBILITY

PRODUCT NAME	FITS 1-1/2"	FITS 2-1/8"
GD1471	No	Yes
GCD9471	Yes	Yes
GD9471	Yes	Yes
SSD9471	Yes	Yes
GCD9571	No	Yes
GDC9471	Yes	Yes
SD9100	Yes	Yes

HANDLESET DEADBOLT BORE HOLE COMPATIBILITY

PRODUCT NAME	FITS 1-1/2"	FITS 2-1/8"
Amador	Yes	Yes
Augusta	Yes	Yes
Branton	Yes	Yes
Brentford	No	Yes
Brentwood	Yes	Yes
Caerus	No	Yes
Daytona	Yes	Yes
Hawthorne	Yes	Yes
Henley	Yes	Yes
Heritage	Yes	Yes
Kingsway	Yes	Yes
Prague	No	Yes
Prescott	No	Yes
San Clemente	No	Yes
Tavaris	Yes	Yes
Vancouver	No	Yes

ELECTRONIC DEADBOLT BORE HOLE COMPATIBILITY

PRODUCT NAME	FITS 1-1/2"	FITS 2-1/8"
Halo Select	No	Yes
Halo Touch	No	Yes
Halo Touchscreen	No	Yes
Halo Keypad	Yes	Yes
Aura Reach	Yes	Yes
Smartcode Touchpad	Yes	Yes
SmartCode Keypad	Yes	Yes
Powerbolt 3	Yes	Yes
Elements Keypad	Yes	Yes

Backset Information

Backset is the distance from centre edge of the door to centre of the 1-1/2" or 2-1/8" diameter hole, 2-3/4" or 2-3/8" in most cases.

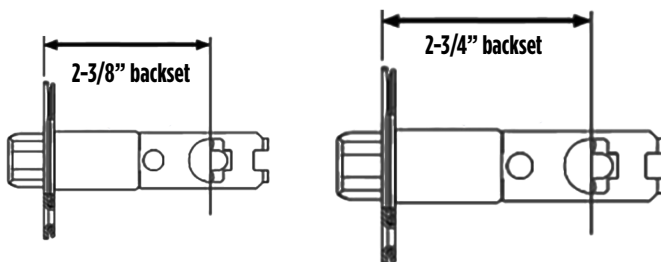

Door Bore Hole Information

The bore hole is the diameter hole where the product is installed (illustrated by the red circle). Typical dimensions are 1-1/2" or 2-1/8"

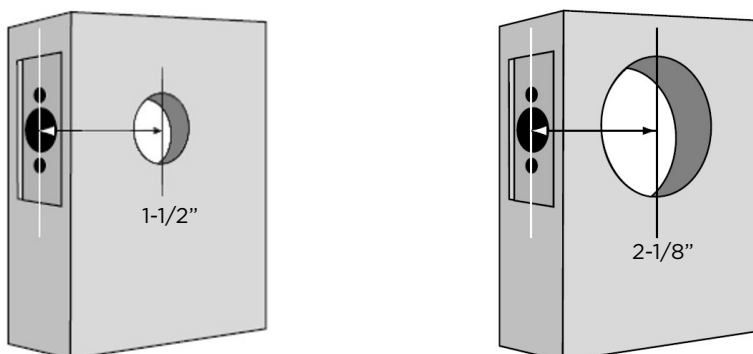

DEADBOLT STRIKES

PART NUMBER

820049/84248

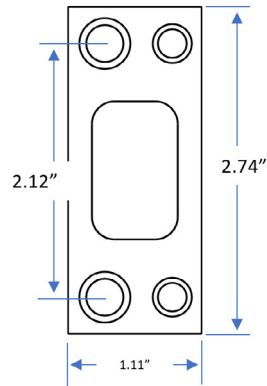

820050

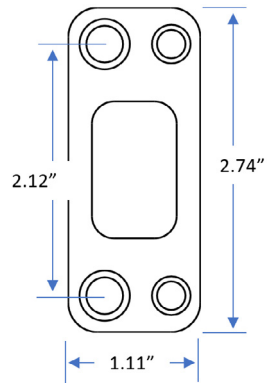

84358

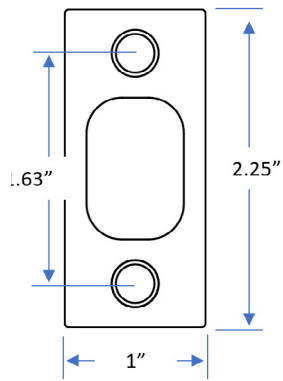

85278

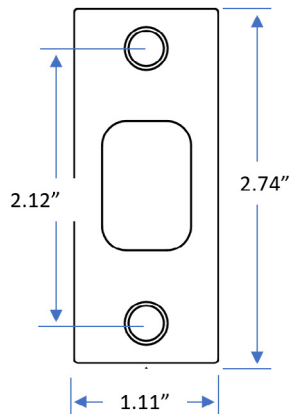

Intro

Electronics

Box Pack

Visual Pack

Padlocks

Parts

DEADBOLT STRIKES

PART NUMBER

85279

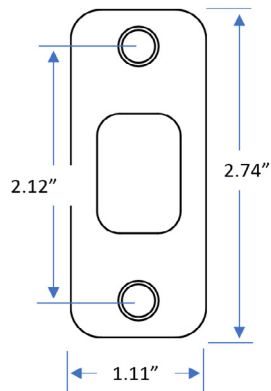

84638

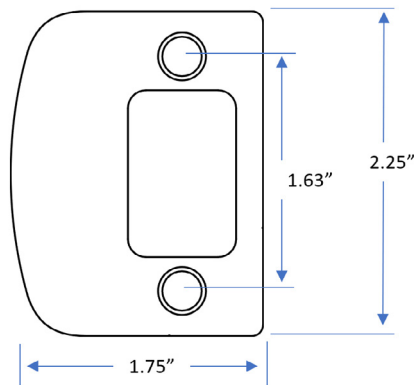

84303

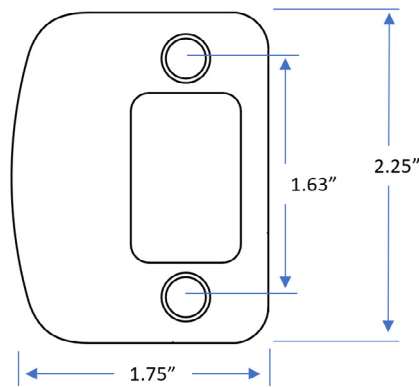

85072

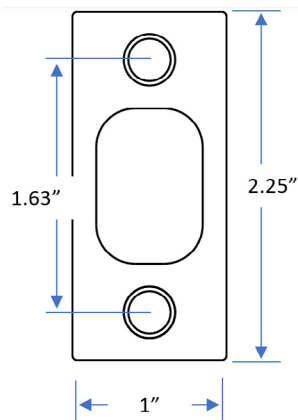

Intro

Electronics

Box Pack

Visual Pack

Padlocks

Parts

DEADBOLT STRIKES

PART NUMBER

85063

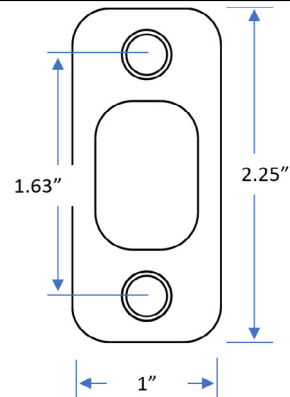

84632

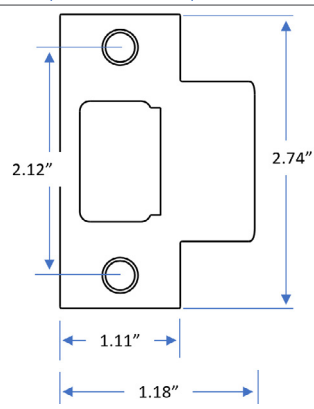

KNOB/LEVER STRIKES

PART NUMBER

83437/83030

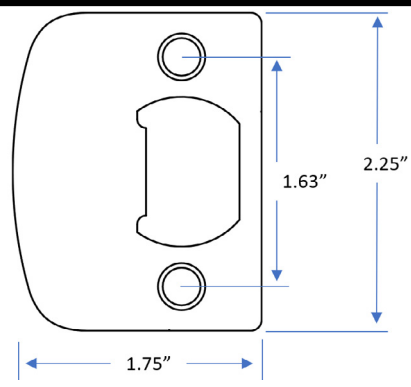

83536/83031

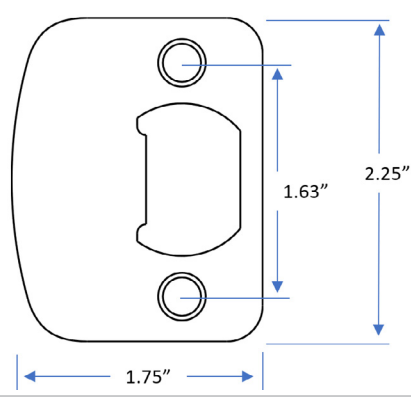

Intro

Electronics

Box Pack

Visual Pack

Padlocks

Parts

KNOB/LEVER STRIKES

PART NUMBER

83028

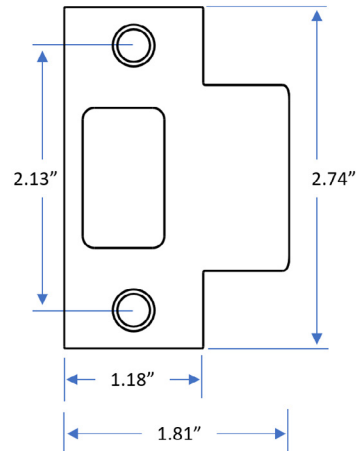

83846

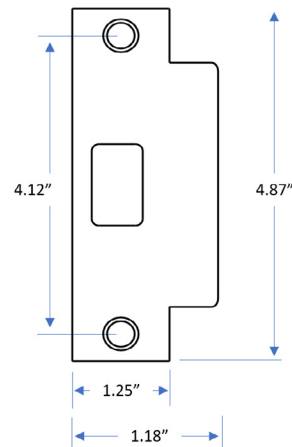

EXTENDED KNOB/LEVER STRIKES

PART NUMBER

83537

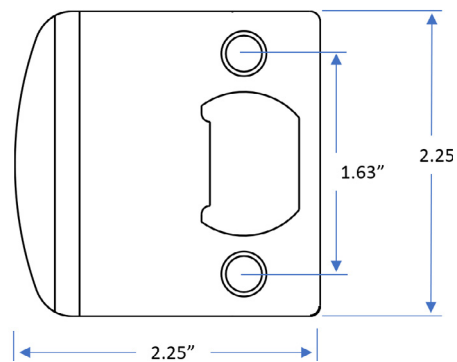

DEADBOLT LATCHES

PART NUMBER

Intro

Electronics

Box Pack

Visual Pack

Padlocks

Parts

820288

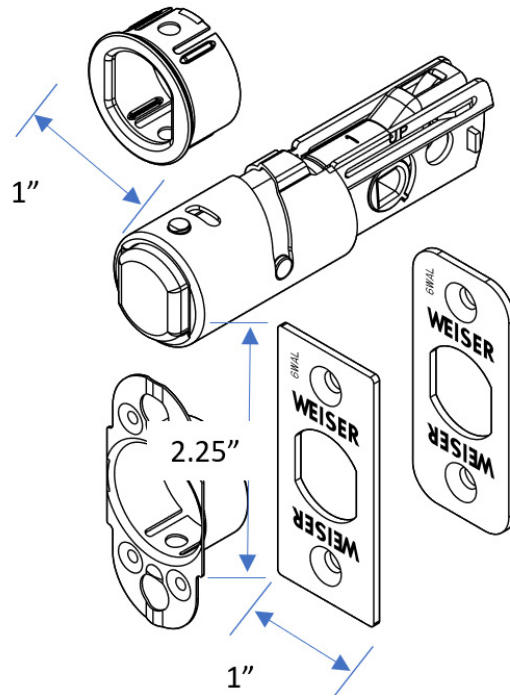

83715

